

TWO
**NEW OUTDOOR
FLOOR EXPERIENCE**
20 MM
FINE PORCELAIN STONEWARE



CONTEMPORARY MATERIAL MADE IN ITALY



**TWO: THE SUPER RESISTANCE
OF 20 MM PORCELAIN STONWARE**

A MONOLITHIC SLAB OF FINE PORCELAIN STONWARE, 20 MM THICK, SURFACE FINISHES FEATURING A HIGH NON-SLIP R11 A+B+C PERFORMANCE. THANKS TO ITS OUTSTANDING TECHNICAL PERFORMANCE, TWO IS CENTURY'S IDEAL SOLUTION FOR EXTERNAL FLOORING FOR BOTH PUBLIC AND PRIVATE AREAS.

**TWO: LA GRANDE RÉSISTANCE
D'UN GRÈS ÉMAILLÉ DE 20 MM**

UNE PLAQUE MONOLITHIQUE EN GRÈS CERAME FIN, 20 MM D'ÉPAISSEUR, FINITIONS DE LA SURFACE CARACTÉRISÉES PAR DES PRESTATIONS ANTIDÉRAPANTES ÉLEVÉES R11 A+B+C. TWO, GRÂCE À SES PRESTATIONS TECHNIQUES EXCEPTIONNELLES, EST LA SOLUTION IDÉALE DE CENTURY POUR LES SOLS EXTÉRIEURS AUSSI BIEN PUBLICS QUE PRIVÉS.

**TWO: DIE HOHE WIDERSTANDSFÄHIGKEIT
EINES 20 MM STARKEN FEINSTEINZEUGS**

EINE MONOLITHISCHE PLATTE AUS FEINSTEINZEUG, STÄRKE 20 MM. DIE OBERFLÄCHENGESTALTUNG ZEICHNET SICH DURCH HOHE RUTSCHFESTIGKEIT AUS: R11 A+B+C. TWO IST DANK SEINER AUSSERGEWÖHNLICHEN TECHNISCHEN EIGENSCHAFTEN DIE IDEALE LÖSUNG VON CENTURY FÜR BODENBELÄGE FÜR ÖFFENTLICHE UND PRIVATE AUSSENBEREICHE.

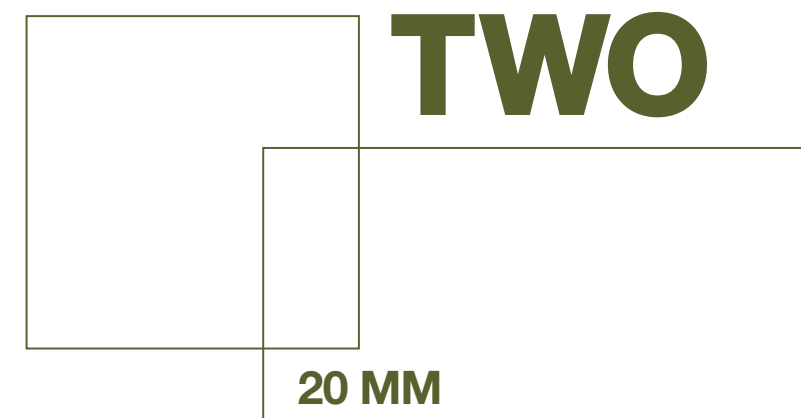

**NEW OUTDOOR
FLOOR EXPERIENCE**

**TWO
LA SUPER
RESISTENZA
DI UN GRES
PORCELLANATO
20 MM
OUTDOOR FREEDOM**

UNA LASTRA MONOLITICA DI GRES FINE PORCELLANATO, 20 MM DI SPESSORE, FINITURE SUPERFICIALI CARATTERIZZATE DA ALTE PRESTAZIONI ANTISCIVOLO R11 A+B+C. TWO, GRAZIE ALLE SUE PRESTAZIONI TECNICHE ECCEZIONALI, È LA SOLUZIONE DI CENTURY IDEALE PER LE PAVIMENTAZIONI ESTERNE SIA PUBBLICHE CHE PRIVATE.



GRES FINE PORCELLANATO

TWO

20 MM

INDEX

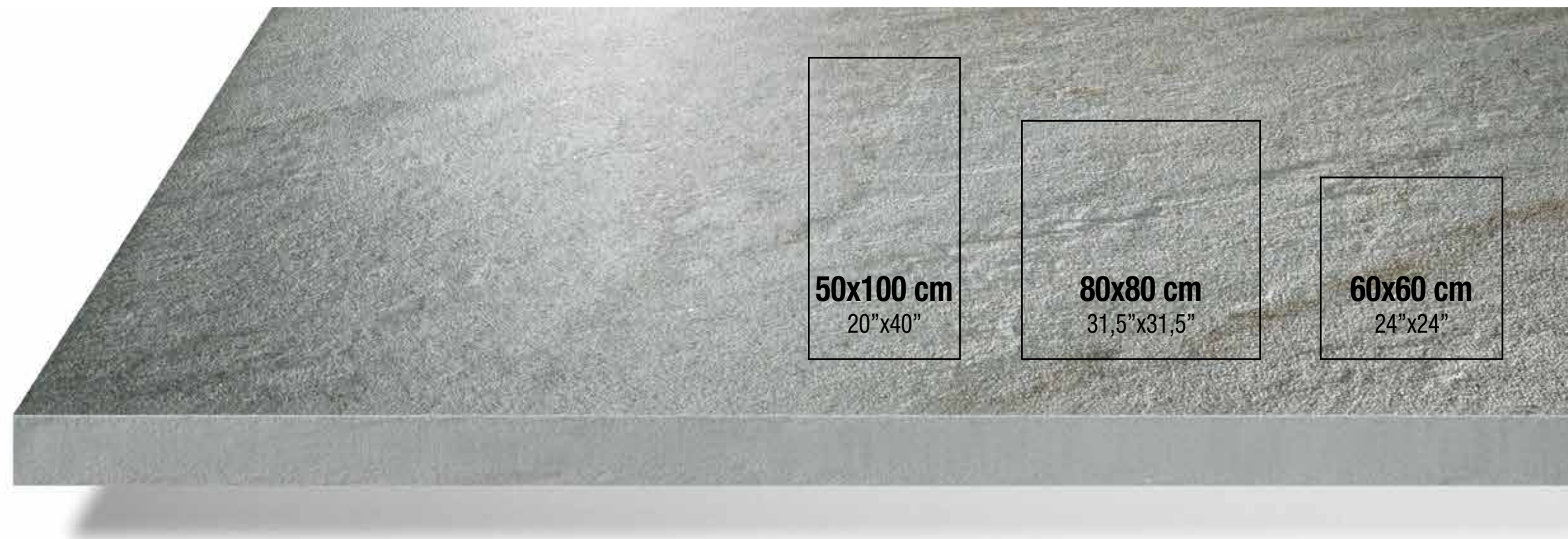

pag. 4-5

PLUS SOLUZIONI DI POSA DESTINAZIONI D'USO

BENEFITS
LES PLUS
DIE VORZÜGE

INSTALLATION SOLUTIONS
SOLUTIONS DE POSE
VERLEGUNGSMÖGLICHKEITEN

INTENDED USES
UTILISATIONS PRÉVUES
VERWENDUNGSZWECKE

pag. 8

POSA A SECCO SU GHIAIA

DRY INSTALLATION ON GRAVEL
POSE À SEC SUR GRAVIER
TROCKENVERLEGUNG AUF KIES

pag. 12

POSA A SECCO SU SABBIA

DRY INSTALLATION ON SAND
POSE À SEC SUR SABLE
TROCKENVERLEGUNG AUF SAND

pag. 16

POSA A SECCO SU ERBA

DRY INSTALLATION ON GRASS
POSE À SEC SUR HERBE
TROCKENVERLEGUNG AUF GRAS

pag. 20

POSA TRADIZIONALE SU MASSETTO

TRADITIONAL INSTALLATION ON SCREEDS
POSE TRADITIONNELLE SUR CHAPE
HERKÖMMLICHE VERLEGUNG AUF ESTRICH

pag. 28

POSA SOPRAELEVATA SU SUPPORTI

RAISED INSTALLATION ON SUPPORTS
POSE SURÉLEVÉE SUR SUPPORTS
DOPPELBODEN AUF TRÄGERN

pag. 42

POOLS & WELLNESS

POOLS & WELLNESS

pag. 46

COLORI E PEZZI SPECIALI

COLOURS AND SPECIAL PIECES
COULEURS ET PIÈCES SPÉCIALES
FARBEN UND FORMSTÜCKE

pag. 57

LA NORMATIVA

THE STANDARD
LA RÉGLEMENTATION
NORMEN

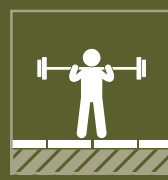

ALTA RESISTENZA AI CARICHI DI ROTTURA E ALLE SOLLECITAZIONI

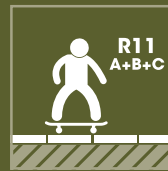

ALTE PRESTAZIONI ANTISDRUCCIOLO:
R11 A+B+C



FACILITÀ DI PULIZIA



ALTA RESISTENZA AL GELO ED AL FUOCO



RESISTENZA AGLI AGENTI ATMOSFERICI E AGLI SBALZI TERMICI



RESISTENZA AL SALE ED INALTERABILITÀ NEL TEMPO



INATTACCABILE DAGLI ACIDI



PERFETTA CONTINUITÀ INTERNO/ESTERNO



RIUTILIZZABILE



FACILITÀ DI POSA, RIMOZIONE E RIPOSIZIONAMENTO:
NON RICHIEDE L'INTERVENTO DI UN POSATORE SPECIALIZZATO (NEL CASO DI POSA A SECCO) E L'UTILIZZO DI COLLANTI E STUCCHI (NEL CASO DI POSA A SECCO E SOPRAELEVATA)

I PLUS DI TWO:

BENEFITS - LES PLUS - DIE VORZÜGE

- HIGH RESISTANCE TO BREAKING LOADS AND STRESS
- HIGH NON-SLIP PERFORMANCE: R11 A+B+C
- EASY TO CLEAN
- HIGH RESISTANCE TO FROST AND FIRE
- RESISTANCE TO THE WEATHERING ELEMENTS AND THERMAL SHOCK
- RESISTANCE TO SALT AND INALTERABILITY OVER TIME
- RESISTANT TO ACIDS
- PERFECT CONTINUITY BETWEEN INDOOR AND OUTDOOR AREAS
- REUSABLE
- EASY TO INSTALL, REMOVE AND REPOSITION: IT DOES NOT REQUIRE A SPECIALIZED TILE LAYER (IN CASE OF DRY INSTALLATION) NEITHER THE USE OF GLUES AND GROUTS (IN CASE OF DRY OR RAISED INSTALLATION)
- GRANDE RÉSISTANCE AUX CHARGES DE RUPTURE ET AUX PRESSIONS
- PRESTATIONS ANTIDÉRAPANTES ÉLEVÉES: R11 A+B+C
- FACILITÉ DE NETTOYAGE
- GRANDE RÉSISTANCE AU GEL ET AU FEU
- RÉSISTANCE AUX AGENTS ATMOSPHÉRIQUES ET AUX ÉCARTS DE TEMPÉRATURE
- RÉSISTANCE AU SEL ET INALTÉRABILITÉ AU FIL DU TEMPS
- NATTAQUABLE PAR LES ACIDES
- PARFAITE CONTINUITÉ INTÉRIEUR-EXTÉRIEUR
- RÉUTILISABLE
- FACILITÉ DE POSE, RETRAIT ET REPOSITIONNEMENT: L'INTERVENTION D'UN POSEUR SPÉCIALISÉ N'EST PAS NÉCESSAIRE (DANS LE CAS DE LA POSE À SEC) ET NI L'USAGE DE COLLES ET DE PLÂTRES (DANS LE CAS DE LA POSE À SEC ET SURÉLEVÉE)
- HOHE BESTÄNDIGKEIT GEGEN BRUCHLAST UND ALLGEMEINE BEANSPRUCHUNGEN
- HOHE RUTSCHFESTIGKEIT: R11 A+B+C
- EINFACH ZU REINIGEN
- HOHE BESTÄNDIGKEIT GEGEN FROST UND FEUER
- BESTÄNDIGKEIT GEGEN WITTERUNGSEINFLÜSSE UND TEMPERATURSCHWANKUNGEN
- SALZBESTÄNDIGKEIT UND LANGE LEBENSDAUER
- SÄUREBESTÄNDIG
- PERFEKTE KONTINUITÄT ZWISCHEN INNEN- UND AUSSENBEREICHEN
- WIEDERVERWENDBAR
- EINFACHES VERLEGEN, ENTFERNEN UND ERNEUTES ANBRINGEN: DER EINGRIFF EINES FACHVERLEGERS (BEI TROCKENVERLEGUNG) SOWIE DER GEBRAUCH VON KLEBSTOFF UND MÖRTEL (BEI TROCKENVERLEGUNG ODER AUF TRÄGERN) SIND NICHT ERFORDERLICH

TWO: SOLUZIONI DI POSA

INSTALLATION SOLUTIONS - SOLUTIONS DE POSE - VERLEGUNGSMÖGLICHKEITEN

LE DESTINAZIONI D'USO DI TWO:

INTENDED USES - UTILISATIONS PRÉVUES - VERWENDUNGSZWECKE

I PLUS DI TWO LO RENDONO IL MATERIALE OTTIMALE PER REALIZZARE OGNI TIPO DI PAVIMENTAZIONE IN AMBIENTI ESTERNI SIA PUBBLICI CHE PRIVATI. TWO RAPPRESENTA LA MIGLIORE SOLUZIONE PER LA REALIZZAZIONE DI:

- CAMMINAMENTI ALL'INTERNO DI GIARDINI O SU SPIAGGE
- TERRAZZE E BALCONI
- PATII, CORTILI, BORDI PISCINA E ZONE WELLNESS
- PERCORSI CARRABILI

THE BENEFITS OF TWO MAKE IT THE MOST SUITABLE MATERIAL FOR ANY KIND OF OUTDOOR FLOORING IN BOTH PUBLIC AND PRIVATE AREAS.

TWO REPRESENTS THE BEST SOLUTION FOR:

- WALKWAYS IN GARDENS OR ON BEACHES
- TERRACES AND BALCONIES
- PATIOS, COURTYARDS, POOLSIDES AND WELLNESS
- DRIVE-OVER PATHWAYS

GRÂCE AUX PLUS DE TWO, CE MATÉRIEL EST PARFAIT POUR RÉALISER TOUT TYPE DE SOL EN MILIEUX EXTERNES AUSSI BIEN PUBLICS QUE PRIVÉS.

TWO REPRÉSENTE LA MEILLEURE SOLUTION POUR LA RÉALISATION DE:

- CHEMINEMENTS DANS LES JARDINS OU SUR LES PLAGES
- TERRASSES ET BALCONS
- PATIOS, COURS, BORDS DE PISCINE ET WELLNESS
- VOIES DE CIRCULATION POUR VÉHICULES

SEINE VORZÜGE MACHEN AUS TWO DAS OPTIMALE MATERIAL FÜR JEDE ART BODENBELAG IN ÖFFENTLICHEN UND PRIVATEN AUSSENBEREICHEN.

TWO BIETET DIE BESTE LÖSUNG FÜR:

- FUSSWEGE IN GÄRTEN ODER AN STRÄNDEN
- TERRASSEN UND BALKONE
- INNENHÖFE, HÖFE, SCHWIMMBADUMRANDUNGEN UND WELLNESS
- BEFAHRBARE WEGE



A SECCO SU GHIAIA

DRY INSTALLATION ON GRAVEL

A SEC SUR GRAVIER

TROCKEN AUF KIES

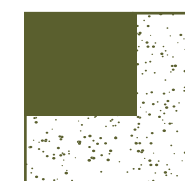

A SECCO SU SABBIA

DRY INSTALLATION ON SAND

A SEC SUR SABLE

TROCKEN AUF SAND



A SECCO SU ERBA

DRY INSTALLATION ON GRASS

A SEC SUR HERBE

TROCKEN AUF GRAS



TRADIZIONALE SU MASSETTO

TRADITIONAL INSTALLATION ON SCREEDS

TRADITIONNELLE SUR CHAPE

AUF HERKÖMMLICHE WEISE AUF ESTRICH

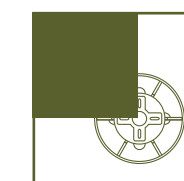

SOPRAELEVATA SU SUPPORTI

RAISED INSTALLATION ON SUPPORTS

SURÉLEVÉE SUR SUPPORTS

ALS DOPPELBODEN AUF TRÄGERN

TWO

E' LA POSA INDICATA PER PAVIMENTAZIONI PEDONABILI SU SOTTOFONDI IN ERBA, SABBIA O GHIAIA.

TWO VIENE SEMPLICEMENTE POSATA, SENZA UTILIZZO DI COLLANTI O STUCCHI, SUL SOTTOFONDO CREANDO CAMMINAMENTI IMMEDIATAMENTE CALPESTABILI, PERFETTAMENTE INTEGRATI ED ECOLOGICI.

THIS IS THE INSTALLATION TECHNIQUE SUITABLE FOR WALKWAY PAVEMENTS ON GRASS, SAND OR GRAVEL BEDDINGS.

TWO IS SIMPLY LAID ON THE SUBSTRATE WITHOUT USING ADHESIVES OR GROUTS, THEREBY CREATING WALKWAYS THAT ARE IMMEDIATELY ACCESSIBLE, PERFECTLY INTEGRATED AND ECO-FRIENDLY.

ELLE EST INDIQUÉE POUR DES SOLS POUR PIÉTONS SUR SOUS-COUCHES D'HERBE, DE SABLE OU DE GRAVIER.

TWO EST SIMPLEMENT POSÉE, SANS UTILISER DE COLLES OU DE PLÂTRES, SUR LA SOUS-COUCHE CRÉANT AINSI DES CHEMINEMENTS IMMÉDIATEMENT PRATICABLES, PARFAITEMENT INTÉGRÉS ET ÉCOLOGIQUES.

DIESE ART VERLEGUNG IST FÜR BEGEHBARE BODENBELÄGE AUF UNTERLAGEN AUS GRAS, SAND ODER KIES GEEIGNET.

TWO WIRD GANZ EINFACH OHNE KLEBER ODER MÖRTEL AUF DEM UNTERGRUND VERLEGT. DABEI ENTSTEHEN PERFEKT INTEGRIERTE, UMWELTFREUNDLICHE FUSSWEGE, DIE SOFORT BEGEHBAR SIND.

POSA A SECCO

DRY INSTALLATION - POSE À SEC - TROCKENVERLEGUNG

TWO: POSA A SECCO SU GHIAIA

DRY INSTALLATION ON GRAVEL - POSE À SEC SUR GRAVIER - TROCKENVERLEGUNG AUF KIES

LA POSA SU GHIAIA HA IL VANTAGGIO DI CONSENTIRE IL DRENAGGIO DELLE ACQUE PIOVANE.



INSTALLATION ON GRAVEL HAS THE ADVANTAGE OF ALLOWING THE DRAINAGE OF RAINWATER.

L'AVANTAGE DE LA POSE SUR GRAVIER EST DE PERMETTRE LE DRAINAGE DES EAUX DE PLUIE.

BEI DER VERLEGUNG AUF KIES BESTEHT DER VORTEIL, DASS DAS REGENWASSER DIREKT ABLAUFEN KANN.

01



UTILIZZARE CROCINI DISTANZIATORI



POSIZIONARE LA PIASTRELLA

- | 1 | 2 | 3 |
|--|---|---|
| LEVEL THE GRAVEL.
NIVELER LE GRAVIER.
DEN KIES EBENEN. | POSITION THE TILE.
PLACER LE CARREAU.
DIE FLIESE POSITIONIEREN. | USE CROSS SPACERS.
UTILISER DES CROISILLONS.
FLIESENKREUZE VERWENDEN. |



LIVELLARE LA GHIAIA



Ambiente realizzato con: - Setting realized with:
Ambiance réalisée avec: - Fotos mit:



HAMILTON UPTOWN

50x100 - 20"x40" grip

20 mm

POSA A SECCO SU SABBIA

DRY INSTALLATION ON SAND - POSE À SEC SUR SABLE - TROCKENVERLEGUNG AUF SAND



TWO: POSA A SECCO SU SABBIA

DRY INSTALLATION ON SAND - POSE À SEC SUR SABLE - TROCKENVERLEGUNG AUF SAND

LA POSA SU SABBIA È PARTICOLARMENTE INDICATA PER SPIAGGE E STABILIMENTI BALNEARI (IN PARTICOLARE NEI COLORI CHIARI).

INSTALLATION ON SAND IS PARTICULARLY SUITABLE FOR BEACHES AND LIDOS (ESPECIALLY IN LIGHT COLOURS).

LA POSE SUR SABLE EST PARTICULIÈREMENT INDIQUÉE POUR LES PLAGES ET LES ÉTABLISSEMENTS BALNÉAIRES (NOTAMMENT DANS LES TONS CLAIRS).

DIE VERLEGUNG AUF SAND IST BESONDERS FÜR STRÄNDE UND SCHWIMMANLAGEN GEEIGNET (VOR ALLEM IN DEN HELLEN FARBEN).

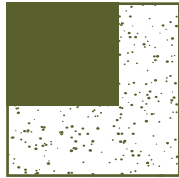

LIVELLARE LA SABBIA



UTILIZZARE CROCINI DISTANZIATORI



POSIZIONARE LA PIASTRELLA

- | | | |
|--|---|---|
| 1 | 2 | 3 |
| LEVEL THE SAND.
NIVELER LE SABLE.
DEN SAND EBENEN. | POSITION THE TILE.
PLACER LE CARREAU.
DIE FLIESE POSITIONIEREN. | USE CROSS SPACERS.
UTILISER DES CROISILLONS.
FLIESENKREUZE VERWENDEN. |



Ambiente realizzato con: - Setting realized with:
Ambiance réalisée avec: - Fotos mit:



DESERT_TWO.0

60x60 - 24"x24" grip

20 mm

POSA A SECCO SU ERBA

DRY INSTALLATION ON GRASS - POSE À SEC SUR HERBE - TROCKENVERLEGUNG AUF GRAS



TWO: POSA A SECCO SU ERBA

DRY INSTALLATION ON GRASS - POSE À SEC SUR HERBE - TROCKENVERLEGUNG AUF GRAS

LA POSA SU ERBA CONSENTE LA REALIZZAZIONE ALL'INTERNO DI PARCHI E GIARDINI DI CAMMINAMENTI DEL TUTTO ORIGINALI, PERSONALIZZABILI E MODIFICABILI NEL TEMPO.

INSTALLATION ON GRASS ALLOWS TO CREATE ORIGINAL, CUSTOMISABLE WALKWAYS IN PARKS AND GARDENS THAT CAN BE CHANGED OVER TIME.

LA POSE SUR L'HERBE PERMET DE RÉALISER AU SEIN DE PARCS ET JARDINS DES CHEMINEMENTS TOUT À FAIT ORIGINAUX, PERSONNALISABLES ET MODIFIABLES AU FIL DU TEMPS. DIE VERLEGUNG AUF

GRAS ERMÖGLICHT DIE VERWIRKLICHUNG VON ORIGINELLEN UND INDIVIDUELL GESTALTETEN FUSSWEGEN IN PARKS UND GÄRTEN, DIE SPÄTER WIEDER VERÄNDERT WERDEN KÖNNEN.



POSIZIONARE LE PIASTRELLE DISTANZIANDO LE A PIACERE A SECONDA DELL'EFFETTO ESTETICO CHE SI VUOLE OTTENERE E RIMUOVERE LA SUPERFICIE ERBOSA



VERSARE LO STABILIZZANTE DI GHIAIA E SABBIA PER MIGLIORARE LA TENUTA DEL SOTTOFONDO



POSIZIONARE LA PIASTRELLA



1 LAY THE TILES BY SPACING THEM DEPENDING ON THE DESIRED AESTHETIC EFFECT AND REMOVE THE GRASSY SURFACE.

PLACER LES CARREAUX EN LES ÉLOIGNANT À SOUHAIT SELON L'EFFET ESTHÉTIQUE QUE VOUS SOUHAITEZ OBTENIR ET ÉLIMINER LA SURFACE DE GAZON.

DIE FLIESEN POSITIONIEREN; DABEI DEN ABSTAND JE NACH GEWÜNSCHTER ÄSTHETISCHER WIRKUNG FESTLEGEN; DIE GRASFLÄCHE ENTFERNEN.

2 SPILL THE GRAVEL AND SAND STABILISER TO IMPROVE THE TIGHTNESS OF THE SUBSTRATE.

VERSER LE STABILISANT COMPOSÉ DE GRAVIER ET SABLE AFIN D'AMÉLIORER L'ÉTANCHÉITÉ DE LA SOUS-COUCHE.

DAS STABILISIERUNGSMITTEL AUS KIES UND SAND AUFTRAGEN, UM DIE FESTIGKEIT DES UNTERGRUNDS ZU VERBESSERN.

3 POSITION THE TILE.

PLACER LE CARREAU.

DIE FLIESE POSITIONIEREN.

TWO

LA STRAORDINARIA RESISTENZA DEL GRES FINE PORCELLANATO SU 20 MM DI SPESSORE CONSENTE A TWO, POSATO CON LA TECNICA TRADIZIONALE SU MASSETTO, DI RAPPRESENTARE LA SOLUZIONE IDEALE ANCHE PER LA REALIZZAZIONE DI PAVIMENTAZIONI CARRABILI. NATURALMENTE, IN QUESTI CASI, SI RACCOMANDA L'OTTIMALE COMPLANARITÀ DEL MASSETTO, LA DOPPIA SPALMATURA DELL'ADESIVO E IL MANTENIMENTO DI FUGHE DI 5 MM TRA UN PEZZO E L'ALTRO.

THE EXTRAORDINARY RESISTANCE OF THIS 20 MM FINE PORCELAIN STONEWARE MEANS TWO, LAID WITH THE TRADITIONAL TECHNIQUE ON SCREEDS, IS THE IDEAL SOLUTION ALSO FOR PAVING DRIVEWAYS. OBVIOUSLY, IN THESE CASES, WE RECOMMEND AN OPTIMAL COPLANARITY OF THE SCREED, USING THE DOUBLE COATING TECHNIQUE FOR ADHESIVE AND 5 MM JOINTS BETWEEN PIECES.

LA RÉSISTANCE EXTRAORDINAIRE DU GRÈS CERAME FIN SUR 20 MM D'ÉPAISSEUR PERMET À TWO, POSÉ SELON LA TECHNIQUE TRADITIONNELLE SUR CHAPE, DE REPRÉSENTER LA SOLUTION IDÉALE MÊME POUR RÉALISER DES SOLS DESTINÉS À LA CIRCULATION DE VÉHICULES. BIEN SÛR, DANS CE CAS, NOUS RECOMMANDONS LA COPLANARITÉ PARFAITE DE LA CHAPE, LE DOUBLE ÉTALAGE DE L'ADHÉSIF ET LE RESPECT DE FUITES DE 5 MM ENTRE UNE PIÈCE ET L'AUTRE.

DIE AUSSERORDENTLICHE WIDERSTANDSFÄHIGKEIT DES FEINSTEINZEUGS IN DER STÄRKE 20 MM MACHT TWO, BEI HERKÖMMLICHER VERLEGUNG AUF ESTRICH AUCH BEI BEFAHRBAREN BODENBELÄGEN ZUR IDEALEN LÖSUNG. NATÜRLICH IST IN DIESEN FÄLLEN FÜR DIE OPTIMALE PLANHEIT DES ESTRICHS, DIE DOPPELTE KLEBERSCHICHT UND DEN BEIBEHALT VON 5 MM BREITEN FUGEN ZWISCHEN DEN FLIESEN ZU SORGEN.

POSA TRADIZIONALE SU MASSETTO

TRADITIONAL INSTALLATION ON SCREEDS - POSE TRADITIONNELLE SUR CHAPE - HERKÖMMLICHE VERLEGUNG AUF ESTRICH

04

Ambiente realizzato con: - Setting realized with:
Ambiance réalisée avec: - Fotos mit:



ASH STONE Stonerock

50x100 - 20"x40" grip

20 mm

POSA TRADIZIONALE SU MASSETTO

TRADITIONAL INSTALLATION ON SCREEDS - POSE TRADITIONNELLE SUR CHAPE - HERKÖMMLICHE VERLEGUNG AUF ESTRICH

04



Ambiente realizzato con: - Setting realized with:
Ambiance réalisée avec: - Fotos mit:

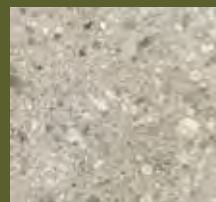

TRACE_REACTION

80x80 - 31,5"x31,5" grip

20 mm



Ambiente realizzato con: - Setting realized with:
Ambiance réalisée avec: - Fotos mit:

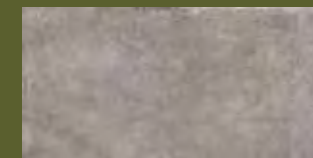

GREY_FUSION

50x100 - 20"x40" grip

20 mm



TWO: POSA TRADIZIONALE SU MASSETTO*

TRADITIONAL INSTALLATION ON SCREEDS* - POSE TRADITIONNELLE SUR CHAPE* - HERKÖMMLICHE VERLEGUNG AUF ESTRICH*



1
SPREAD THE ADHESIVE EVENLY USING THE DOUBLE COATING TECHNIQUE (BOTH ON THE SUBSTRATE AND ON THE BACK OF THE TILE).

ÉTALER L'ADHÉSIF DE FAÇON HOMOGÈNE SELON LA TECHNIQUE DU DOUBLE ÉTALAGE (AUSSI BIEN SUR LE FOND QUE SUR LA PARTIE SITUÉE AU VERSO DU CARREAU).

DEN KLEBER MIT DER DOPPELSCHICHTTECHNIK GLEICHMÄSSIG AUFTRAGEN (SOWOHL AUF DEM UNTERGRUND ALS AUCH AUF DER RÜCKSEITE DER FLIESE).

2
POSITION THE TILE. PLACER LE CARREAU. DIE FLIESE POSITIONIEREN.



3
USE CROSS SPACERS (5 MM JOINTS). UTILISER DES CROISILLONS (FUGITE 5 MM). FLIESENKREUZE VERWENDEN (5 MM FUGE).

4
GROUT THE FLOOR. PLÂTRER LE SOL. DEN BODENBELAG VERFUGEN.

5
CLEAN THE SURFACE THOROUGHLY. NETTOYER SOIGNEUSEMENT LA SURFACE. DIE OBERFLÄCHE GRÜNDLICH REINIGEN.



* SI CONSIGLIA DI FAR RIFERIMENTO AL RAPPORTO TECNICO CEN / TR 13548 "REGOLE GENERALI PER LA PROGETTAZIONE E L'ESECUZIONE DELLE PIASTRELLATURE CERAMICHE". SI RACCOMANDA, INOLTRE, DI VERIFICARE LA CAPACITÀ PORTANTE E LA QUALITÀ DEL PIANO DI POSA PRIMA DELL'INSTALLAZIONE DELLE PIASTRELLE. INFINE, SI CONSIGLIA UNA PENDENZA MINIMA DELL'1,5%.

* PLEASE REFER TO THE TECHNICAL REPORT CEN/TR 13548 "GENERAL RULES FOR THE DESIGN AND INSTALLATION OF CERAMIC TILING". YOU ARE ALSO ADVISED TO CHECK THE SUPPORT CAPACITY AND QUALITY OF THE LAYING SURFACE BEFORE INSTALLING THE TILES. LASTLY, A MINIMUM SLOPE IS ADVISED OF 1.5%.

* NOUS CONSEILLONS DE SE RÉFÉRER AU LIVRET TECHNIQUE CEN / TR 13548 "CONSIGNES GÉNÉRALES POUR LA CONCEPTION ET L'EXÉCUTION DES CARRELAGES CÉRAMIQUES". AVANT L'INSTALLATION DES CARREAUX, IL CONVIENT ÉGALEMENT DE VÉRIFIER LA CAPACITÉ PORTANTE AINSI QUE LA QUALITÉ DU PLAN DE POSE. ENFIN, NOUS CONSEILLONS UNE INCLINAISON MINIMUM DE 1.5%.

* ES EMPFIEHLT SICH, DEN TECHNISCHEN BERICHT DER EG-NORM / TR 13548 "ALLGEMEINE REGELN FÜR DIE PLANUNG UND VERLEGUNG VON KERAMIKFLIESEN" ZU HILFE ZU NEHMEN. ES WIRD DES WEITEREN EMPFOHLEN, VOR DEM VERLEGEN DER FLIESEN DIE TRAGFÄHIGKEIT UND DIE QUALITÄT DER AUFLAGEFLÄCHE ZU PRÜFEN. ES WIRD EINE MINDESTNEIGUNG VON 1.5% EMPFOHLEN.

* SI RACCOMANDA IN QUESTI CASI UN'ADEGUATA ED OTTIMALE COMPLANARITÀ DEL MASSETTO, LA DOPPIA SPALMATURA DELL'ADESIVO PER LA POSA E IL MANTENIMENTO DI FUGHE DI 5 MM TRA LE LASTRE.

* THIS TYPE OF INSTALLATION REQUIRES OPTIMAL COPLANARITY OF THE SCREED, DOUBLE LAYER OF ADHESIVE, AND 5 MM JOINTS BETWEEN THE SLABS.

* DANS CES CAS-LÀ, UN BON NIVELLEMENT DE LA FONDATION EST DE MISE LE DOUBLE ENDUISAGE DE L'ADHÉSIF POUR LA POSE ET LE MAINTIEN D'ÉVACUATIONS DE 5 MM ENTRE LES PLAQUES.

* IN DIESEN FÄLLEN WIRD EINE ANGEMESSENE UND OPTIMALE EBENUNG DES ESTRICHS, EINE DOPPELTE SCHICHT DES VERWENDETEN FLIESENKLEBERS UND EIN FUGENABSTAND VON 5 MM ZWISCHEN DEN PLATTEN EMPFOHLEN.

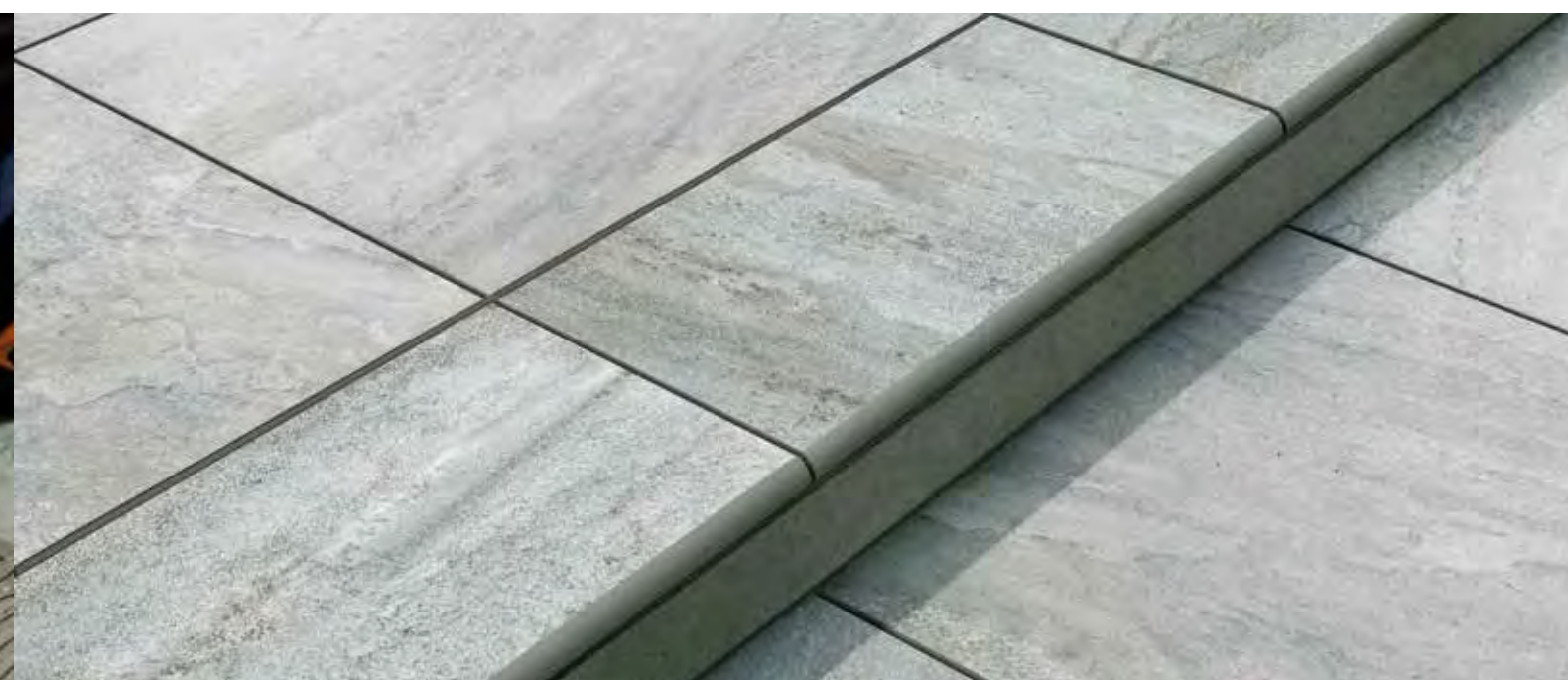

TWO

TWO RAPPRESENTA LA SOLUZIONE IDEALE ANCHE PER POSE FLOTTANTI IN AMBIENTI ESTERNI SU 3 DIVERSE TIPOLOGIE DI SUPPORTI PORTANTI IN POLIPROPILENE. LA POSSIBILITÀ DI CREARE UN VANO TRA IL SOTTOFONDO ED IL PIANO DI CALPESTIO, UNITO ALLA FUGA APERTA DI 3-4 MM IMPOSTA DALLE ALETTE DISTANZIATRICI PRESENTI SULLA SOMMITÀ DEI SUPPORTI, CONSENTONO SIA UN FACILE DRENAGGIO DELLE ACQUE PIOVANE CHE LA POSSIBILITÀ DI RICAVARE UN PREZIOSO SPAZIO SEMPRE ISPEZIONABILE DESTINATO AL PASSAGGIO DI IMPIANTI DI QUALSIASI GENERE (ILLUMINAZIONE, IRRIGAZIONE, ECC.).

TWO REPRESENTS THE IDEAL SOLUTION ALSO FOR FLOATING INSTALLATION IN OUTDOOR ENVIRONMENTS ON 3 DIFFERENT TYPES OF POLYPROPYLENE LOAD-BEARING SUPPORTS. THE POSSIBILITY OF CREATING A SHAFT BETWEEN THE SUBSTRATE AND THE FLOOR SURFACE, COMBINED WITH THE OPEN 3-4 MM JOINTS CREATED BY THE SPACER TRIMS ON TOP OF THE SUPPORTS, ALLOWS BOTH TO EASILY DRAIN RAINWATER AND OBTAIN A USEFUL SPACE THAT CAN BE INSPECTED AT ANY TIME, INTENDED TO PASS ANY KIND OF SYSTEM (LIGHTING, IRRIGATION, ETC.).

TWO EST LA SOLUTION IDÉALE ÉGALEMENT POUR DES POSES FLOTTANTES EN MILIEUX EXTERNES SUR 3 TYPES DIFFÉRENTS DE SUPPORTS PORTANTS EN POLYPROPYLÈNE. LA POSSIBILITÉ DE CRÉER UN PETIT COMPARTIMENT ENTRE LA SOUS-COUCHE ET LA SURFACE PRACTICABLE, UNI À LA FUITE OUVERTE DE 3-4 MM IMPOSÉE PAR LES AILETTES INTERCALAIRES PRÉSENTES AU SOMMET DES SUPPORTS, PERMETTENT UN DRAINAGE FACILITÉ DES EAUX DE PLUIES AINSI QUE LA POSSIBILITÉ DE BÉNÉFICIER D'UN ESPACE PRÉCIEUX TOUJOURS CONTRÔLABLE DESTINÉ AU PASSAGE DE TOUT TYPE DE SYSTÈMES (ÉCLAIRAGE, IRRIGATION, ETC.).

TWO STELLT AUCH BEI SCHWIMMENDER VERLEGUNG IN AUSSENBEREICHEN AUF 3 VERSCHIEDENEN TRÄGERN AUS POLYPROPYLEN DIE IDEALE LÖSUNG DAR. DA ZWISCHEN DEM UNTERGRUND UND DER BEGEBBAREN FLÄCHE EIN RAUM ERZEUGT WERDEN KANN UND ZUDEM EINE OFFENE FUGE VON 3-4 MM VORHANDEN IST, DIE DURCH DIE DISTANZFLÜGEL OBEN AN DEN TRÄGERN GEBILDET WIRD, IST SOWOHL EIN PROBLEMLOSER ABFLUSS DES REGENWASSERS ALS AUCH DIE MÖGLICHKEIT GEGEBEN, EINEN WERTVOLLEN, STETS ÜBERPRÜFBAREN ZWISCHENRAUM ZU ERHALTEN, DURCH DEN ALLE ARTEN VON ANLAGEN (BELEUCHTUNG, BEWÄSSERUNG, USW) VERLAUFEN KÖNNEN.

POSA SOPRAELEVATA SU SUPPORTI

RAISED INSTALLATION ON SUPPORTS - POSE SURÉLEVÉE SUR SUPPORTS - DOPPELBODEN AUF TRÄGERN

05

Ambiente realizzato con: - Setting realized with:
Ambiance réalisée avec: - Fotos mit:



MINERAL_GEOLOGY

50x100 - 20"x40" grip rett.

20 mm



HABITAT_GEOLOGY

50x100 - 20"x40" grip rett.

20 mm

POSA SOPRAELEVATA SU SUPPORTI

RAISED INSTALLATION ON SUPPORTS - POSE SURÉLEVÉE SUR SUPPORTS - DOPPELBODEN AUF TRÄGERN



TWO: POSA SOPRAELEVATA SU SUPPORTI

RAISED INSTALLATION ON SUPPORTS - POSE SURÉLEVÉE SUR SUPPORTS - DOPPELBODEN AUF TRÄGERN

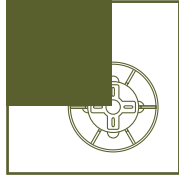

1
POSIZIONARE LE PIASTRELLE SOPRA AI SUPPORTI
PRECEDENTEMENTE DISTRIBUITI

1

LAY THE TILES ON THE SUPPORTS PREVIOUSLY ARRANGED.
PLACER LES CARREAUX SUR LES SUPPORTS RÉPARTIS AUPARAVANT.
DIE FLIESEN AUF DEN ZUVOR VERTEILTEN TRÄGERN POSITIONIEREN.

* SI RACCOMANDA DI VERIFICARE LA CAPACITÀ PORTANTE E LA QUALITÀ DEL PIANO DI POSA PRIMA DELL'INSTALLAZIONE DELLE PIASTRELLE. INFINE, SI CONSIGLIA UNA PENDENZA MINIMA DELL'1,5%.

* YOU ARE ADVISED TO CHECK THE SUPPORT CAPACITY AND QUALITY OF THE LAYING SURFACE BEFORE INSTALLING THE TILES. LASTLY, A MINIMUM SLOPE IS ADVISED OF 1.5%.

2

USE A SUPPORT AT THE CENTRE OF THE SLAB (60X60 CM) TO ENSURE AN EVEN LOAD DISTRIBUTION.
UTILISER UN SUPPORT AU CENTRE DE LA PLAQUE (60X60 CM) POUR UNE RÉPARTITION UNIFORME DE LA CHARGE.
EINEN TRÄGER IN DER MITTE DER PLATTE VERWENDEN (60X60 CM), DAMIT DIE LASTVERTEILUNG GLEICHMÄSSIG AUSFÄLLT.

* AVANT L'INSTALLATION DES CARREAUX, IL CONVIENT ÉGALEMENT DE VÉRIFIER LA CAPACITÉ PORTANTE AINSI QUE LA QUALITÉ DU PLAN DE POSE. ENFIN, NOUS CONSEILLONS UNE INCLINAISON MINIMUM DE 1,5%.

* ES WIRD EMPFOHLEN, VOR DEM VERLEGEN DER FLIESEN DIE TRAGFÄHIGKEIT UND DIE QUALITÄT DER AUFLAGEFLÄCHE ZU PRÜFEN. ES WIRD EINE MINDESTNEIGUNG VON 1,5% EMPFOHLEN.



2
UTILIZZARE UN SUPPORTO AL CENTRO DELLA LASTRA (60X60 CM)
PER UNA UNIFORME DISTRIBUZIONE DEL CARICO



3
VERIFICARE LA COPLANARITÀ DELLA SUPERFICIE



4
INTERVENIRE NELL'EVENTUALITÀ CON LA CHIAVE DI REGOLAZIONE

3

CHECK THE COPLANARITY AND LEVELLING OF THE SURFACE.
VÉRIFIER LA COPLANARITÉ ET LE NIVELLEMENT DE LA SURFACE.
DIE GLEICHMÄSSIGE HÖHE UND DIE NIVELLIERUNG DER OBERFLÄCHE KONTROLLIEREN.

4

USE THE ADJUSTMENT KEY IF NECESSARY. INTERVENIR SI NÉCESSAIRE A L'AIDE DE LA CLÉ DE RÉGLAGE.
BEI BEDARF DEN NIVELLIERSSCHLÜSSEL VERWENDEN.



TWO: LE 3 TIPOLOGIE DI SUPPORTI

THE 3 TYPES OF SUPPORTS - LES 3 TYPES DE SUPPORTS - DIE 3 VERSCHIEDENEN TRÄGERARTEN

SUPPORTI FISSI - FIXED SUPPORTS - SUPPORTS FIXES - FESTE TRÄGER



SUPPORTO EH12 - EH15 - EH20

DISCO LIVELLATORE LH3

I SUPPORTI AD ALTEZZA FISSA SONO DISPONIBILI IN TRE VERSIONI: IL MODELLO EH12 (H.12MM), EH15 (H.15MM) E EH20 (H.20MM). DA SEMPRE RAPPRESENTANO LA SOLUZIONE PIÙ RAPIDA ED ECONOMICA PER LA POSA DI PIASTRE NEL SISTEMA SOPRAELEVATO. IL DISCO LIVELLATORE LH3 (SPESSORE 3MM) PUÒ INFINE ESSERE UTILIZZATO SOPRA O SOTTO QUALSIASI SUPPORTO E FUNGE DA SPESSORE PER UNO O PIÙ SETTORI DEL MEDESIMO.

EH12 - EH15 - EH20 SUPPORTS LEVELLING DISK LH3

THE FIXED HEIGHT SUPPORTS ARE AVAILABLE IN THREE VERSIONS: EH12 (H.12MM), EH15 (H.15MM) AND EH20 (H.20MM). THEY REPRESENT THE FASTEST AND MOST ECONOMIC SOLUTION FOR LAYING FLOOR TILES ON A RAISED FLOOR SYSTEM. THE LEVELLING DISK LH3 (THICKNESS 3MM) CAN BE USED OVER OR UNDER ANY SUPPORT AND ACTS AS A SHIM FOR ONE OR MORE AREAS.

SUPPORT EH12 - EH15 - EH20

DISQUE DIAMANT LH3

LES SUPPORTS À HAUTEUR FIXE SONT DISPONIBLES EN TROIS VERSIONS: LE MODÈLE EH12 (H.12 MM), EH15 (H.15 MM) ET EH20 (H.20 MM) REPRÉSENTENT DEPUIS TOUJOURS LA SOLUTION LA PLUS RAPIDE ET LA PLUS ÉCONOMIQUE POUR LA POSE DE DALLES DANS LE SYSTÈME SURÉLEVÉ. LE DISQUE DIAMANT LH3 (ÉPAISSEUR 3 MM) PEUT ENFIN ÊTRE UTILISÉ AU-DESSUS OU AU-DESSOUS DE TOUT SUPPORT ET SERT D'ÉPAISSISSEUR POUR UN OU PLUSIEURS SECTEURS.

TRÄGER EH12 • EH15 • EH20

RICHTSCHEIBE LH3

DIE STELLFÜSSE IN VERSCHIEDENEN HÖHEN SIND IN DREI AUSFÜHRUNGEN LIEFERBAR: MODELL EH12 (H.12MM), EH15 (H.15MM) UND EH20 (H.20MM). SIE STELLEN SEIT JEHER DIE SCHNELLSTE UND PREISGÜNSTIGSTE LÖSUNG FÜR FLIESENVERLEGUNG BEI DOPPELBÖDEN DAR. DIE RICHTSCHEIBE LH3 (STÄRKE 3MM) KANN ZUDEM ÜBER ODER UNTER JEDEM TRÄGER ANGEBRACHT WERDEN UND HEBT EINEN ODER MEHRERE VON DESSEN SEKTOREN AN.



EH12 - 12 MM



EH15 - 15 MM



EH20 - 20 MM

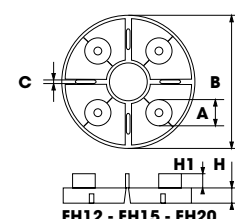

EH12 - EH15 - EH20



LH3 SPESSORE-LIVELLATORE
LEVELLER-SHIM
DISQUE DIAMANT DE SURFAÇAGE
RICHTSCHEIBE

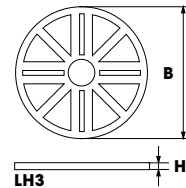

LH3



PER I PREZZI DEI SUPPORTI SI PREGA DI CONTATTARE GLI UFFICI COMMERCIALI.

FOR THE PRICE OF THE MOUNTINGS, PLEASE CONTACT THE SALES OFFICE.

POUR LES TARIFS DES SUPPORTS, NOUS VOUS PRIONS DE BIEN VOULOIR CONTACTER LES SERVICES COMMERCIAUX.

FÜR PREISE DER UNTERLAGEN BITTE UNSERE VERTRIEBSBÜROS KONTAKTIEREN.

SUPPORTI REGOLABILI IN ALTEZZA - HEIGHT-ADJUSTABLE SUPPORTS - SUPPORTS RÉGLABLES EN HAUTEUR - HÖHENVERSTELLBARE TRÄGER



1 CHIAVE DI REGOLAZIONE (NOTA: L'USO DELLA CHIAVE È POSSIBILE SOLO FINO A UN MASSIMO DI 2 PIASTRE)

ADJUSTMENT KEY (NOTE: THE USE OF THE KEY IS ONLY POSSIBLE UP TO A MAXIMUM OF 2 PLATES)
CLÉ DE RÉGLAGE (NOTE : L'UTILISATION DE LA CLÉ EST POSSIBLE JUSQU'À 2 PLAQUES MAX. UNIQUEMENT.)
EINSTELLSCHLÜSSEL (ANMERKUNG: DIE VERWENDUNG DES EINSTELLSCHLÜSSELS IST NUR FÜR MAXIMAL ZWEI PLATTEN MÖGLICH)

2 COMPENSATORE DI PENDENZA TWIST TW150

TWIST SLOPE COMPENSATOR TW 150
COMPENSATEUR DE PENTE DE TORSION TW 150
NEIGUNGSAUSGLEICHER TWIST TW 150

3 STAR.T 10-15 MM

4 PROLUNGA STAR.T +5MM

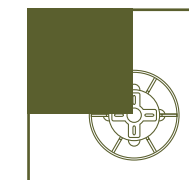

PER I PREZZI DEI SUPPORTI SI PREGA DI CONTATTARE GLI UFFICI COMMERCIALI.

FOR THE PRICE OF THE MOUNTINGS, PLEASE CONTACT THE SALES OFFICE.

POUR LES TARIFS DES SUPPORTS, NOUS VOUS PRIONS DE BIEN VOULOIR CONTACTER LES SERVICES COMMERCIAUX.

FÜR PREISE DER UNTERLAGEN BITTE UNSERE VERTRIEBSBÜROS KONTAKTIEREN.

SUPPORTO REGOLABILE "STAR.T", PROLUNGA STAR.T E COMPENSATORE DI PENDENZA TWIST TW 150
IL SUPPORTO "STAR.T" È COMPOSTO DA UNA PARTE SUPERIORE FISSA DI 8 MM A CUI È ABBINATA UNA BASE CHE CONSENTE DI RAGGIUNGERE I 15 MM, USUFRUENDO DI UNA REGOLAZIONE MILLIMETRICA GRAZIE ALLA CHIAVE DI REGOLAZIONE.

STAR.T È DOTATO DELLA "PROLUNGA STAR.T", UN SUPPORTO FISSO CHE PUÒ ESSERE POSIZIONATO SOTTO LO STAR.T PER INCREMENTARE L'ALTEZZA DI 5 MM, POTENDO COSÌ ARRIVARE AD UN'ALTEZZA DI 30 MM. LA REGOLAZIONE DELLA PENDENZA È CONTROLLATA DAGLI APPOSITI COMPENSATORI DI PENDENZA "TWIST TW 150" IN MODO DA REALIZZARE UN PAVIMENTO PERFETTAMENTE ORIZZONTALE E FACILITARNE LA POSA. STAR.T È UN SUPPORTO CON PORTATA CERTIFICATA E LE SUE ALETTE DISTANZIATRICI SONO STATE CONCEPITE PER ESSERE FACILMENTE ASPORTATE PER L'APPLICAZIONE NEGLI ANGOLI O CONTRO MURO.

VANTAGGI:

- POSSIBILITÀ DI SOPRAELEVARE 8 MM GRAZIE ALLA PARTE FISSA
- REGOLAZIONE MILLIMETRICA DA 10 A 30 MM, GRAZIE ALLA CHIAVE DI REGOLAZIONE E ALL'AGGIUNTA DI +5 MM PER VOLTA CON LE PROLUNGHE STAR.T
- REGOLAZIONE DELLA PENDENZA, GRAZIE AL COMPENSATORE DI PENDENZA TW 150
- ALETTE FACILMENTE ASPORTABILI
- ELEVATA TECNICITÀ

ADJUSTABLE "STAR.T" SUPPORT, STAR.TE EXTENSION TWIST TW 150 SLOPE COMPENSATOR

THE "STAR.T" SUPPORT IS COMPOSED OF A 8 MM FIXED UPPER PART WITH A BASE THAT ALLOWS TO REACH 15 MM, USING MILLIMETRIC ADJUSTMENT BY MEANS OF AN ADJUSTMENT KEY. STAR.T IS EQUIPPED WITH THE "STAR.T EXTENSION", A FIXED SUPPORT THAT CAN BE POSITIONED UNDER THE STAR.T TO INCREASE THE HEIGHT OF 5 MM, TO REACH UP TO A HEIGHT OF 30 MM. ADJUSTMENT OF THE SLOPE IS CONTROLLED BY THE SPECIAL "TWIST TW 150" SLOPE COMPENSATORS IN ORDER TO CREATE A PERFECTLY HORIZONTAL FLOOR AND FACILITATE INSTALLATION. STAR.T IS A SUPPORT WITH CERTIFIED CAPACITY, AND ITS SPACERS HAVE BEEN CONCEIVED TO BE EASILY RELEASED FOR APPLICATION IN CORNERS OR WALLS.

ADVANTAGES:

- POSSIBILITY OF AN 8 MM LIFT THANKS TO THE FIXED SECTION
- MILLIMETRIC ADJUSTMENT FROM 10 TO 30 MM, THANKS TO THE ADJUSTMENT KEY AND THE ADDITION OF +5 MM PER TURN WITH STAR.T EXTENSIONS
- SLOPE ADJUSTMENT THANKS TO THE TW 150 SLOPE COMPENSATOR
- EASILY REMOVABLE BOLTS
- HIGHLY TECHNICAL

SUPPORT RÉGLABLE " STAR.T ", EXTENSION STAR.T ET COMPENSATEUR DE PENTE TWIST TW 150

LE SUPPORT " STAR.T " EST COMPOSÉ PAR UNE PARTIE SUPÉRIEURE FIXE DE 8 MM À LAQUELLE EST ASSOCIÉE UNE BASE QUI PERMET D'ATTEINDRE 15 MM, EN UTILISANT UN RÉGLAGE MILLIMÉTRICAL GRÂCE À LA CLÉ D'AJUSTEMENT. STAR.T EST L'ÉQUIPEMENT DE L' " EXTENSION STAR.T ", UN SUPPORT FIXE QUI PEUT ÊTRE POSITIONNÉ EN DESSOUS DE STAR.T POUR AUGMENTER LA HAUTEUR DE 5 MM EN PERMETTANT D'OBTENIR UNE HAUTEUR DE 30 MM. LE RÉGLAGE DE LA PENTE EST CONTRÔLÉ PAR LES COMPENSATEURS DE PENTE SPÉCIAUX " TWIST TW 150 " AFIN DE CRÉER UN SOL PARFAITEMENT HORIZONTAL ET DE FACILITER LA POSE. STAR.T EST UN SUPPORT AVEC UNE CAPACITÉ DE CHARGE CERTIFIÉE ET SES ENTRETOISES ONT ÉTÉ CONÇUES POUR ÊTRE FACILEMENT DÉMONTABLES POUR UNE APPLICATION DANS LES COINS OU CONTRE LE MUR.

LES AVANTAGES:

- POSSIBILITÉ DE SURÉLEVER DE 8 MM GRÂCE À LA PARTIE FIXE
- RÉGLAGE MILLIMÉTRIQUE DE 10 A 30 MM, GRÂCE À LA CLÉ D'AJUSTEMENT ET À L'AJOUT DE +5 MM À LA FOIS AVEC LES EXTENSIONS STAR.T
- RÉGLAGE DE LA PENTE GRÂCE AU COMPENSATEUR DE PENTE TW 150
- ENTRETOISES FACILEMENT AMOVIBLES
- HAUTE TECHNICITÉ

EINSTELLBARES STELZLAGER "STAR.T", STELZLAGER VERLÄNGERUNG STAR.T UND NEIGUNGSAUSGLEICHER TWIST TW 150

DAS STELZLAGER "STAR.T" BESTEHT AUS EINEM FESTEN KOPF VON 8 MM UND EINEM FUSS, MIT DEM UNTER MILLIMETERGENAUEREINSTELLUNG MIT HILFE DES EINSTELLSCHLÜSSELS SEINE HÖHE VON 15 MM ERREICHBAR IST. STAR.T VERFÜGT ÜBER DIE "VERLÄNGERUNG STAR.T", EIN TRÄGER, DER UNTER DAS STELZLAGER STAR.T GESCHOBEN WERDEN KANN UND ES UM BIS ZU 5 MM UND AUF EINE GESAMTHÖHE VON MAXIMAL 30 MM ERHÖHT. DER AUSGLEICH DES GEFÄLLES WIRD DURCH DIE NEIGUNGSAUSGLEICHER "TWIST TW 150" GEWÄHRLEISTET, DIE DIE REALISIERUNG EINES PERFEKT EBENFLÄCHIGEN BODENS ERMÖGLICHEN UND DIE VERLEGUNG ERLEICHTERN. STAR.T IST EIN STELZLAGER MIT ZERTIFIZIERTER TRAGFÄHIGKEIT UND SEINE ABSTANDSHALTER SIND FÜR DIE VERLEGUNG IN ECK- UND RANDBEREICHEN LEICHT ENTFERNBAR.

VORTEILE:

- MÖGLICHKEIT, MIT DEM FESTEN KOPF UM 8 MM ZU ERHÖHEN
- MILLIMETERGENAUE EINSTELLUNG ZWISCHEN 10 UND 30 MM DANK DES EINSTELLSCHLÜSSELS UND DER HINZUFÜGUNG VON JEWEILS +5 MM MIT DEN STELZLAGER VERLÄNGERUNGEN STAR.T
- AUSGLEICH VON GEFÄLLE DANK DES NEIGUNGSAUSGLEICHERS TW 150
- LEICHT ENTFERNBARE ABSTANDSHALTER
- HOHE TECHNISCHE LEISTUNG



**SUPPORTO REGOLABILE "NEW-MAXI" CON TESTA IN BIMATERIALE (PP+GOMMA)
LIVELLATORE IN GOMMA LGH2 E LGH3**

IL SUPPORTO "NEW-MAXI" RAPPRESENTA IL PRIMO MODELLO DI SUPPORTO REGOLABILE IN ALTEZZA. CONSENTE L'OTTENIMENTO DI VANI TECNICI SOTTOSTANTI IL PIANO DI CALPESTIO PIÙ CAPIENTI RISPETTO A QUELLI OTTENIBILI CON I SUPPORTI FISSI E PERMETTE DI UNIFORMARE E REGOLARE PAVIMENTAZIONI CON ALTEZZE DIVERSE.

"NEW-MAXI" OFFRE ROBUSTEZZA E RESISTENZA AL CARICO E LA REGOLAZIONE DELL'ALTEZZA PER MEZZO DELL'ESCLUSIVA CHIAVE DI REGOLAZIONE. LA TESTA È PROVISTA DI UNA PARTE SUPERIORE IN GOMMA, ANTIRUMORE ED ANTISCIVOLAMENTO. LE ALETTE DISTANZIATRICI SONO STATE CONCEPITE PER ESSERE FACILMENTE ASPORTATE PER L'APPLICAZIONE NEGLI ANGOLI O CONTRO MURO.

VANTAGGI:

- REGOLAZIONE MILLIMETRICA DA 25 A 100 MM
- REGOLAZIONE DELL'ALTEZZA, A PAVIMENTO FINITO, GRAZIE ALL'ESCLUSIVA CHIAVE DI REGOLAZIONE
- TESTA FISSA CON PARTE SUPERIORE IN GOMMA ANTIRUMORE ED ANTISCIVOLAMENTO
- BASE DI APPOGGIO LISCIA DI 320 CM2
- RESISTENTE AGLI AGENTI ATMOSFERICI, AGLI ACIDI, ALL'INVECCHIAMENTO, AI RAGGI UV ED A TEMPERATURE FRA -30° C E +120° C



**"NEW-MAXI" ADJUSTABLE SUPPORT WITH COMPOSITE HEAD IN (PP + RUBBER)
RUBBER LEVELLER LGH2 AND LGH3**

THE "NEW-MAXI" SUPPORT IS THE FIRST HEIGHT ADJUSTABLE SUPPORT MODEL. IT ALLOWS TO CREATE LARGER TECHNICAL SHAFTS UNDERNEATH THE FLOOR SURFACE COMPARED TO THOSE THAT CAN BE OBTAINED WITH FIXED SUPPORTS AND ALLOW TO ADJUST FLOORINGS WITH DIFFERENT HEIGHTS AND ALLOWS THEY ARE UNIFORM. "NEW-MAXI" PROVIDES STRENGTH AND RESISTANCE FOR LOAD AS WELL AS HEIGHT ADJUSTMENT THROUGH THE USE OF THE UNIQUE ADJUSTMENT KEY. THE HEAD IS EQUIPPED WITH A NON-SLIP AND NOISE-PROOF RUBBER CROWN. THE SPACER TRIMS HAVE BEEN DESIGNED TO BE EASILY REMOVED FOR USE IN CORNERS OR AGAINST THE WALL.

ADVANTAGES:

- PRECISE ADJUSTMENT FROM 25 TO 100 MM
- HEIGHT ADJUSTMENT, AT COMPLETED FLOOR THANKS TO THE UNIQUE ADJUSTMENT KEY
- FIXED HEAD WITH A NON-SLIP AND NOISE-PROOF RUBBER CROWN
- SMOOTH STAND 320 CM2
- RESISTANT TO WEATHER, ACID, AGE, UV RAYS AND TEMPERATURES BETWEEN -30° C AND +120° C

**SUPPORT RÉGLABLE "NEW-MAXI" AVEC TÊTE RÉALISÉE EN DEUX MATÉRIAUX (PP+CAOUTCHOUC)
DISQUE DIAMANT EN CAOUTCHOUC LGH2 ET LGH3**

LE SUPPORT "NEW-MAXI" REPRÉSENTE LE PREMIER MODÈLE DE SUPPORT RÉGLABLE EN HAUTEUR. IL PERMET D'OBTENIR DE PETITS COMPARTIMENTS TECHNIQUES SITUÉS EN-DESSOUS DE LA SURFACE PRATICABLE, PLUS GRANDS PAR RAPPORT À CEUX QUE L'ON POURRAIT OBTENIR AVEC LES SUPPORTS FIXES ET PERMET D'UNIFORMISER ET DE RÉGLER LES SOLS DE DIFFÉRENTES HAUTEURS.

"NEW-MAXI" OFFRE ROBUSTESSE ET RÉSISTANCE À LA CHARGE ET PERMET DE RÉGLER LA HAUTEUR AU MOYEN DE LA CLÉ EXCLUSIVE DE RÉGLAGE. LA TÊTE EST DOTÉE D'UNE PARTIE SUPÉRIEURE EN CAOUTCHOUC ANTI-BRUIT ET ANTI-GLISSE. LES AILETTES QUI PERMETTENT D'AUGMENTER LA DISTANCE ONT ÉTÉ CONÇUES POUR ÊTRE FACILEMENT SUPPRIMÉES POUR L'APPLICATION DANS LES COINS OU CONTRE UN MUR.

LES AVANTAGES:

- RÉGLAGE MILLIMÉTRIQUE DE 25 À 100 MM
- RÉGLAGE DE LA HAUTEUR AU SOL FINI GRÂCE À LA CLÉ EXCLUSIVE DE RÉGLAGE
- TÊTE FIXE AVEC PARTIE SUPÉRIEURE EN CAOUTCHOUC ANTI-BRUIT ET ANTI-GLISSE
- BASE D'APPUI LISSE DE 320 CM2
- RÉSISTANT AUX AGENTS ATMOSPHÉRIQUES, AUX ACIDES, AU VIEILLEMENT, AUX RAYONS UV ET AUX TEMPÉRATURES COMPRIS ENTRE -30° C ET + 120° C

**EINSTELLBARER TRÄGER "NEW-MAXI" MIT KOPF AUS VERBUNDMATERIAL (PP+GUMMI)
RICHTSCHEIBE AUS GUMMI LGH2 UND LGH3**

DER TRÄGER "NEW-MAXI" IST DAS ERSTE HÖHENVERSTELLBARE TRÄGERMODELL. DAMIT DIESE TRÄGER KÖNNEN UNTER DER BEGEBHAREN OBERFLÄCHE LIEGENDE, TECHNISCHE ZWISCHENRÄUME ERZIELT WERDEN, DIE IM VERGLEICH ZU DENEN BEI FESTEN TRÄGERN GRÖßER SIND; AUSSERDEM KÖNNEN DAMIT BODENBELÄGE MIT VERSCHIEDENEN HÖHEN ANEINANDER ANGEPAßT UND VEREINHEITLICHT WERDEN. "NEW-MAXI" IST STABIL, HÄLT HOHEN BELASTUNGEN STAND UND IST MIT EINEM SPEZIELLEN SCHLÜSSEL IN DER HÖHE VERSTELLBAR. DER KOPF HAT OBEN EINE GERÄUSCHDÄMMENDE UND RUTSCHFESTE GUMMI-OBERFLÄCHE. DIE ABSTANDSHALTER SIND SO AUSGEFÜHRT, DASS SIE BEI DER ANWENDUNG IN ECKEN ODER AN WÄNDEN LEICHT ENTFERNT WERDEN KÖNNEN.

VORTEILE:

- MILLIMETERGENAUE EINSTELLUNG VON 25 BIS 100 MM
- MIT HILFE DES SPEZIELLEN SCHLÜSSELS NACH VERLEGUNG DES BODENS HÖHENVERSTELLBAR
- FESTER KOPF OBEN MIT GERÄUSCHDÄMMENDER UND RUTSCHFESTER GUMMI-OBERFLÄCHE
- GLATTE AUFLAGEFLÄCHE VON 320 CM2
- BESTÄNDIG GEGEN WITTERUNGSEINFLÜSSE, SÄUREEINWIRKUNG, ALTERUNG, UV-STRAHLUNG UND TEMPERATUREN ZWISCHEN -30° C UND + 120° C

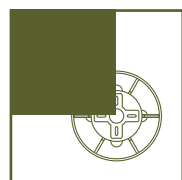

PER I PREZZI DEI SUPPORTI SI PREGA DI CONTATTARE GLI UFFICI COMMERCIALI.

FOR THE PRICE OF THE MOUNTINGS, PLEASE CONTACT THE SALES OFFICE.

POUR LES TARIFS DES SUPPORTS, NOUS VOUS PRIONS DE BIEN VOULOIR CONTACTER LES SERVICES COMMERCIAUX.

FÜR PREISE DER UNTERLAGEN BITTE UNSERE VERTRIEBSBÜROS KONTAKTIEREN.

ALETTE DISTANZIATRICI FACILMENTE ASPORTABILI

SPACER TRIMS EASILY REMOVABLE
AILETTES-ENTRETOISES FACILEMENT AMOVIBLES

LEICHT ENTFERNBARE ABSTANDSFLÜGEL

ESCLUSIVO AGGANCIAMENTO TESTA-VITE: LA TESTA SEMPRE IN SEDE

UNIQUE HOOK HEAD-SCREW: THE HEAD IS ALWAYS IN ITS SEAT
FIXATION EXCLUSIVE TÊTE-VIS : LA TÊTE RESTE TOUJOURS DANS SON LOGEMENT

SPEZIELLE VERBUNDUNG KOPF-SCHRAUBE: DER KOPF SITZT IMMER RICHTIG

PRIMO E UNICO SUPPORTO AL MONDO DOTATO DI TESTA CON FINITURA IN GOMMA IN GRADO DI ABBATTERE IL LIVELLO SONORO $\Delta_1=25dB^*$

FIRST AND ONLY SUPPORT IN THE WORLD EQUIPPED WITH RUBBER FINISHED HEAD ABLE TO REDUCE SOUND LEVEL $\Delta_1=25dB^*$

PREMIER ET SEUL SUPPORT AU MONDE DOTÉ D'UNE TÊTE AVEC FINITION EN CAOUTCHOUC EN MESURE DE RÉDUIRE LE NIVEAU SONORE $\Delta_1=25dB^*$

ERSTER UND EINZIGER TRÄGER DER WELT MIT EINEM GUMMIBESCHICHTETEN KOPF, DER DEN GERÄUSCHPEGEL SENKEN KANN $\Delta_1=25dB^*$

GOMMA ANTISCIVOLAMENTO
NON-SLIP RUBBER
CAOUTCHOUC ANTI-GLISSE
RUTSCHFESTER GUMMI



L'H (dB) REFERENCE (180 717-2) SHIFTED CURVA

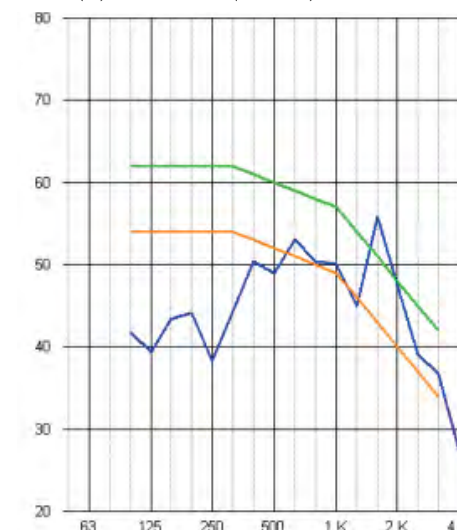

* PROVA EFFETTUATA SU DI UN SOLAIO IN PREDALLE CON PAVIMENTO IN CERAMICA SU SOTTOFONDO IN CLS. PIASTRE DI GHIAINO LAVATO. SUPPORTO SE3 CON TESTA AUTOLIVELLANTE IN BIMATERIALE.

* TESTS CARRIED OUT ON A COMPOSITE FLOOR SLAB ON CERAMIC FLOORING WITH SUBFLOOR/FOUNDATION IN CONCRETE, WASHED GRAVEL TILES. SE3 SUPPORT WITH SELF-LEVELLING COMPOSITE HEAD.

* TEST EFFECTUÉ SUR UN PLANCHER PRÉDALLES AVEC PLANCHER EN CÉRAMIQUE SUR UNE SOUS-COUCHE EN CLS. DALLES DE GRAVAILLON LAVÉ, SUPPORT SE3 AVEC TÊTE AUTO-NIVELANTE EN BI-MATÉRIAL.

* PRÜFUNG ERFOLGTE AUF TRÄGERDECKE AUS FERTIGPLATTEN MIT KERAMIKBODEN AUF BETONUNTERBETTLUNG, FLIESEN AUS WASCHBETON, TRÄGER SE3 MIT GERÄUSCHDÄMMENDEM KOPF AUS VERBUNDWERKSTOFF.

SPESORE-LIVELLATORE IN GOMMA. EFFETTO ANTISCIVOLO E ANTIRUMORE

LEVELLER-SHIM IN NON-SLIP AND NOISE-PROOF RUBBER
DISQUE DIAMANT DE SURFAÇAGE EN CAOUTCHOUC.
EFFET ANTI-GLISSE ET ANTI-BRUIT
GERÄUSCHDÄMMENDE UND RUTSCHFESTE RICHTSCHEIBE AUS GUMMI

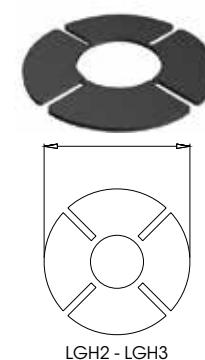

LGH2 - LGH3

CHIAVE DI REGOLAZIONE UTILIZZABILE SOLO CON ALETTA 4 MM

ADJUSTMENT KEY USABLE ONLY WITH 4 MM TRIMS
CLÉ DE RÉGLAGE UTILISABLE UNIQUEMENT AVEC AILETTE 4 MM
EINSTELLSCHLÜSSEL NUR FÜR 4 MM-FLÜGEL VERWENDBAR

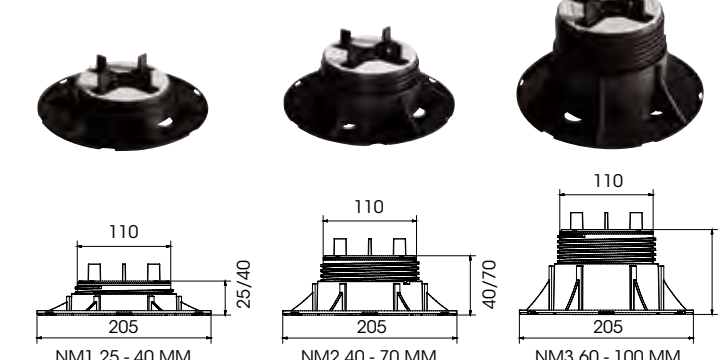

NM1 25 - 40 MM NM2 40 - 70 MM NM3 60 - 100 MM



SUPPORTO REGOLABILE "ETERNO SE" CON TESTA AUTOLIVELLANTE IN BIMATERIALE (PP+GOMMA)

VANTAGGI:

- TESTA AUTOLIVELLANTE CHE COMPENSA AUTOMATICAMENTE PENDENZE FINO AL 5%
- REGOLABILE DA 37,5 A 120 MM CON PAVIMENTO FINITO GRAZIE ALL'ESCLUSIVA CHIAVE DI REGOLAZIONE
- BASE DI APPOGGIO LISCIA DI 320 CM2
- TOTALMENTE RICICLABILE
- RESISTENTE A TEMPERATURE DA -30° C A +120° C
- RESISTENTE AGLI ACIDI, ALL'INVECCHIAMENTO, AI RAGGI UV
- NUOVA TESTA CON PARTE SUPERIORE IN GOMMA ANTIRUMORE ED ANTISCIVOLAMENTO
- ALETTE FACILMENTE ASPORTABILI

"ETERNO SE" ADJUSTABLE SUPPORT WITH SELF-LEVELLING COMPOSITE HEAD (PP + RUBBER)

ADVANTAGES:

- SELF-LEVELLING HEAD THAT AUTOMATICALLY ADJUSTS SLOPE UP TO 5%
- ADJUSTABLE FROM 37.5 TO 120 MM WITH COMPLETED FLOOR THANKS TO THE UNIQUE ADJUSTMENT KEY
- SMOOTH STAND 320 CM2
- FULLY RECYCLABLE
- RESISTANT TO TEMPERATURES FROM -30° C TO + 120° C
- RESISTANT TO ACID, AGE AND UV RAYS
- NEW FIXED HEAD WITH A NON-SLIP AND NOISE-PROOF RUBBER CROWN
- EASILY REMOVABLE TRIMS

SUPPORT RÉGLABLE "ETERNO SE" AVEC TÊTE AUTO-NIVELANTE EN BI-MATÉRIAU (PP+CAOUTCHOUC)

LES AVANTAGES:

- TÊTE AUTO-NIVELANTE QUI COMPENSE AUTOMATIQUÉMENT LES PENTES ALLANT JUSQU'À 5 %
- RÉGLABLE DE 37,5 À 120 MM AVEC SOL FINI GRACE À LA CLÉ EXCLUSIVE DE RÉGLAGE
- BASE D'APPUI LISSE DE 320 CM2
- ENTIÈREMENT RECYCLABLE
- RÉSISTANT AUX TEMPÉRATURES COMPRIS ENTRE -30° C ET + 120° C
- RÉSISTANT AUX ACIDES, AU VIEILLEMENT, AUX RAYONS UV
- NOUVELLE TÊTE AVEC PARTIE SUPÉRIEURE EN CAOUTCHOUC ANTI-BRUIT ET ANTI-GLISSE
- AILETTES FACILEMENT AMOVIBLES

EINSTELLBARER TRÄGER "ETERNO SE" MIT SELBSTNIVELLIERENDEN KÖPFEN AUS VERBUNDWERKSTOFF (PP+GUMMI)

VORTEILE:

- SELBSTNIVELLIERENDER KOPF GLEICHT AUTOMATISCH NEIGUNGEN BIS 5% AUS
- MIT HILFE DES SPEZIELLEN EINSTELLSCHLÜSSELS BEI FERTIG VERLEGTEM FUSSBODEN VON 37,5 BIS 120 MM REGULIERBAR
- GLATTE AUFLAGEFLÄCHE VON 320 CM2
- VOLLSTÄNDIG RECYCLEBAR
- TEMPERATURBESTÄNDIG VON -30° C BIS + 120° C
- BESTÄNDIG GEGEN SÄUREEINWIRKUNG, ALTERUNG UND UV-STRAHLUNG
- NEUER KOPF MIT GERÄUSCHDÄMMENDEM UND RUTSCHFESTEM OBERTEIL
- LEICHT ZU ENTFERNENDE ABSTANDSFLÜGEL

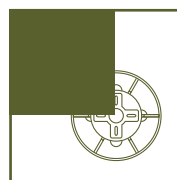

PER I PREZZI DEI SUPPORTI SI PREGA DI CONTATTARE GLI UFFICI COMMERCIALI.

FOR THE PRICE OF THE MOUNTINGS, PLEASE CONTACT THE SALES OFFICE.

POUR LES TARIFS DES SUPPORTS, NOUS VOUS PRIONS DE BIEN VOULOIR CONTACTER LES SERVICES COMMERCIAUX.

FÜR PREISE DER UNTERLAGEN BITTE UNSERE VERTRIEBSBÜROS KONTAKTIEREN.

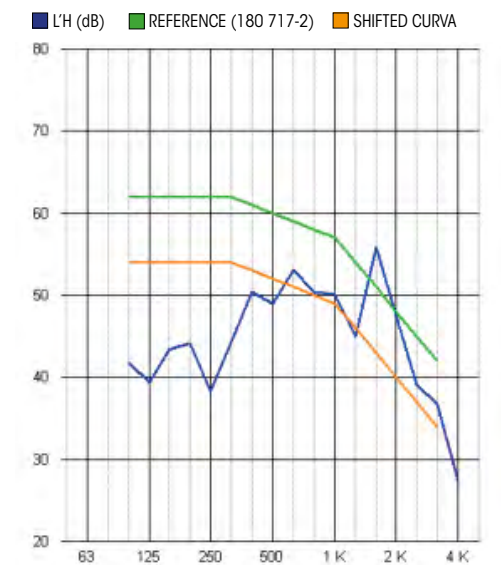
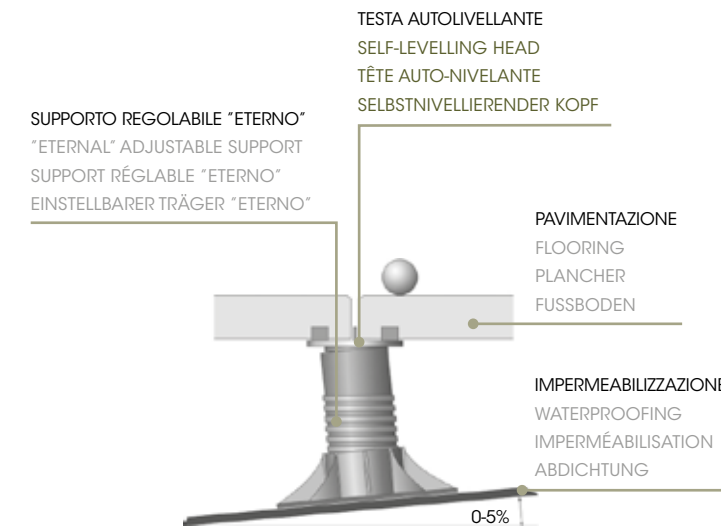

* PROVA EFFETTUATA SU DI UN SOLAIO IN PREDALLE CON PAVIMENTO IN CERAMICA SU SOTTOFONDO IN CLS, PIASTRE DI GHIAINO LAVATO, SUPPORTO SE3 CON TESTA AUTOLIVELLANTE IN BIMATERIALE.

* TESTS CARRIED OUT ON A COMPOSITE FLOOR SLAB ON CERAMIC FLOORING WITH SUBFLOOR/FOUNDATION IN CONCRETE, WASHED GRAVEL TILES, SE3 SUPPORT WITH SELF-LEVELLING COMPOSITE HEAD.

* TEST EFFECTUÉ SUR UN PLANCHER PRÉDALLES AVEC PLANCHER EN CÉRAMIQUE SUR UNE SOUS-COUCHE EN CLS, DALLES DE GRAVAILLON LAVÉ, SUPPORT SE3 AVEC TÊTE AUTO-NIVELANTE EN BI-MATÉRIAU.

* PRÜFUNG ERFOLGTE AUF TRÄGERDECKE AUS FERTIGPLATTEN MIT KERAMIKBODEN AUF BETONUNTERBETTUNG, FLIESEN AUS WASCHBETON, TRÄGER SE3 MIT GERÄUSCHDÄMMENDEM KOPF AUS VERBUNDWERKSTOFF.



CHIAVE DI REGOLAZIONE UTILIZZABILE SOLO CON ALETTA 4 MM
 ADJUSTMENT KEY USABLE ONLY WITH 4 MM TRIMS
 CLÉ DE RÉGLAGE UTILISABLE UNIQUEMENT AVEC AILETTE 4 MM
 EINSTELLSCHLÜSSEL NUR FÜR 4 MM-FLÜGEL VERWENDBAR

PRIMO E UNICO SUPPORTO AL MONDO DOTATO DI TESTA CON FINITURA IN GOMMA IN GRADO DI ABBATTERE IL LIVELLO SONORO $\Delta_i=25\text{dB}$ *
 FIRST AND ONLY SUPPORT IN THE WORLD EQUIPPED WITH RUBBER FINISHED HEAD ABLE TO REDUCE SOUND LEVEL $\Delta_i=25\text{dB}$ *
 PREMIER ET SEUL SUPPORT AU MONDE DOTÉ D'UNE TÊTE AVEC FINITION EN CAOUTCHOUC EN MESURE DE RÉDUIRE LE NIVEAU SONORE $\Delta_i=25\text{dB}$ *
 ERSTER UND EINZIGER TRÄGER DER WELT MIT EINEM GUMMIBESCHICHTETEN KOPF, DER DEN GERÄUSCHPEGEL SENKEN KANN $\Delta_i=25\text{dB}$ *

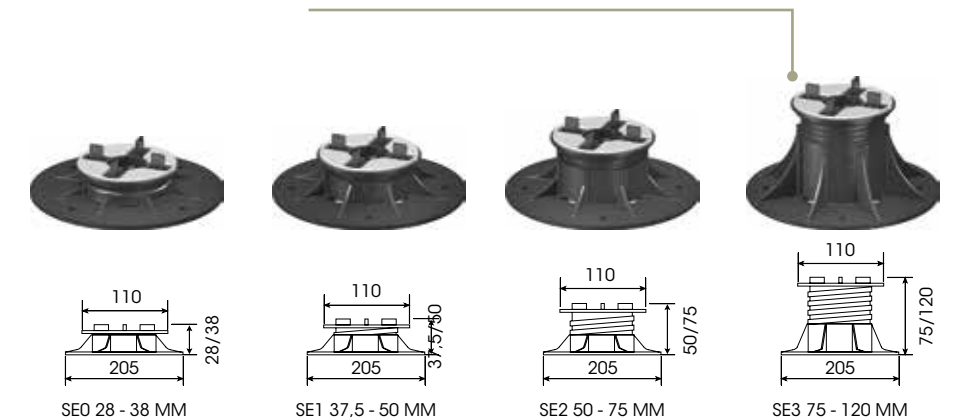



AL FINE DI DISTRIBUIRE NEL MODO PIÙ OMOGENEO I CARICHI, SI RACCOMANDA NELL'UTILIZZO DEL 60X60 - 80X80 L'INSERIMENTO DI UN SUPPORTO CENTRALE ALLA LASTRA RIMUOVENDO LE 4 ALETTE DISTANZIATRICI PRESENTI SULLA SOMMITÀ DEL SUPPORTO (IN CASO DI UTILIZZO DI SUPPORTI REGOLABILI O REGOLABILI/AUTOLIVELLANTI).

IN ORDER TO DISTRIBUTE LOADS AS EVENLY AS POSSIBLE, WE RECOMMEND FOR THE 60X60 - 80X80 SIZE TO USE A CENTRAL SUPPORT IN RELATION TO THE SLAB BY REMOVING THE 4 SPACER TRIMS ON TOP OF THE SUPPORT (WHEN USING ADJUSTABLE OR ADJUSTABLE/SELF-LEVELLING SUPPORTS).

AFIN DE RÉPARTIR DE LA FAÇON LA PLUS HOMOGENÈE LES CHARGES, NOUS RECOMMANDONS POUR LE FORMAT 60X60 - 80X80 L'USAGE D'UN SUPPORT CENTRAL À LA PLAQUE EN RETIRANT LES 4 AILETTES INTERCALAIRES PRÉSENTES AU SOMMET DU SUPPORT (EN CAS D'UTILISATION DE SUPPORTS RÉGLABLES OU RÉGLABLES/AUTO-NIVELANT).

DAMIT DIE BELASTUNG MÖGLICHSST GLEICHMÄSSIG VERTEILT WIRD, EMPFIEHLT SICH BEI DER VERWENDUNG DES FFORMAT 60X60 - 80X80, EINEN TRÄGER IN DER MITTE DER PLATTE ZU VERWENDEN UND DIE 4 DISTANZFLÜGEL AUF DER OBERSEITE DES TRÄGERS ZU ENTFERNEN (BEI VERWENDUNG VON HÖHENVERSTELLBAREN ODER HÖHENVERSTELLBAREN /ELBSTNIVELLIERENDEN TRÄGERN).

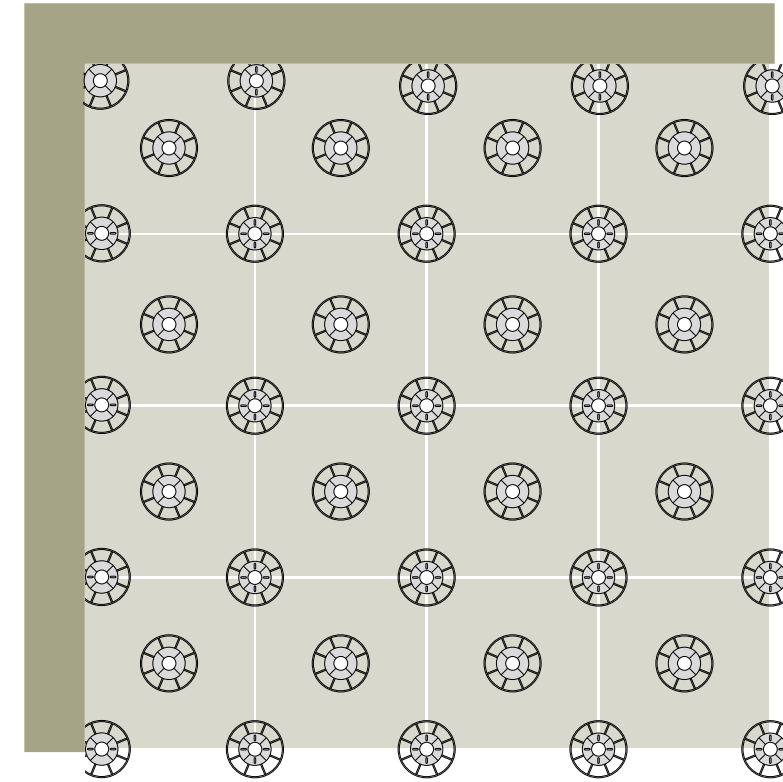

SI PUÒ PROCEDERE ALL'ELIMINAZIONE DI UNA O PIÙ ALETTE DISTANZIATRICI AL FINE DI CONSENTIRE UNA POSA OTTIMALE.

YOU CAN REMOVE ONE OR SEVERAL SPACER TRIMS TO ALLOW FOR OPTIMAL INSTALLATION.

IL EST POSSIBLE D'ÉLIMINER UNE OU PLUSIEURS AILETTES D'ÉCARTEMENT POUR PERMETTRE UNE POSE OPTIMALE.

FÜR EINEN OPTIMALEN EINBAU KÖNNEN EINE ODER MEHRERE ABSTANDSRIPPEN ENTFERNT WERDEN.

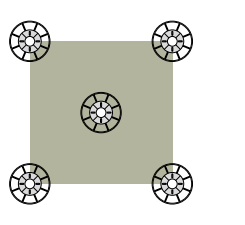
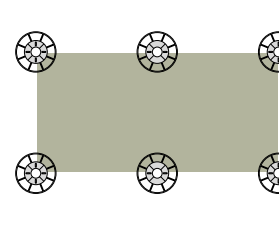
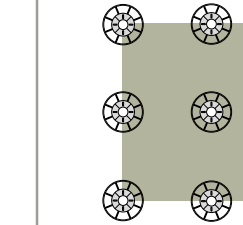
FORMATO SIZE FORMAT FORMAT				
		60X60	50X100	80X80
INCIDENZA SUPPORTI SUPPORTS NUMBERS INCIDENCE DE SUPPORTS DIE ANZAHL DER TRÄGER	supporti / m ²	7,12	5,63	7,91
	supporti / pz	2,56	2,82	5,06



L'INCIDENZA DEL NUMERO DI SUPPORTI AL PEZZO E AL MQ. DI PAVIMENTO POSATO E' VARIABILE IN RELAZIONE ALLE DIMENSIONI DELL'AREA DA RIVESTIRE. IN FUNZIONE DELLA LUNGHEZZA CIOÈ DELLE PARTI PERIMETRALI CHE DETERMINANO UN MAGGIOR IMPIEGO MEDIO DI SUPPORTI PER MQ. POSATO.

THE NUMBER OF SUPPORTS TO THE PIECE AND TO THE SQ.M. OF FLOORING LAID IS VARIABLE IN CONNECTION WITH THE SIZE OF THE AREA TO BE COVERED. AS A LENGTH FUNCTION OF THE PERIMETER PARTS WHICH DETERMINE AN INCREASED AVERAGE USE OF THE SUPPORTS PER SQ.M LAID.

L'INCIDENCE DU NOMBRE DE SUPPORTS PAR PIÈCE ET PAR M2 DE PLANCHER POSÉ VARIE EN FONCTION DES DIMENSIONS DE LA SURFACE À REVÊTIR. EN FONCTION DE LA LONGUEUR C'EST-À-DIRE DES PARTIES PÉRIMÉTRIQUES QUI DÉTERMINENT UNE UTILISATION MAJEURE MOYENNE DE SUPPORTS PAR M2 POSÉ.

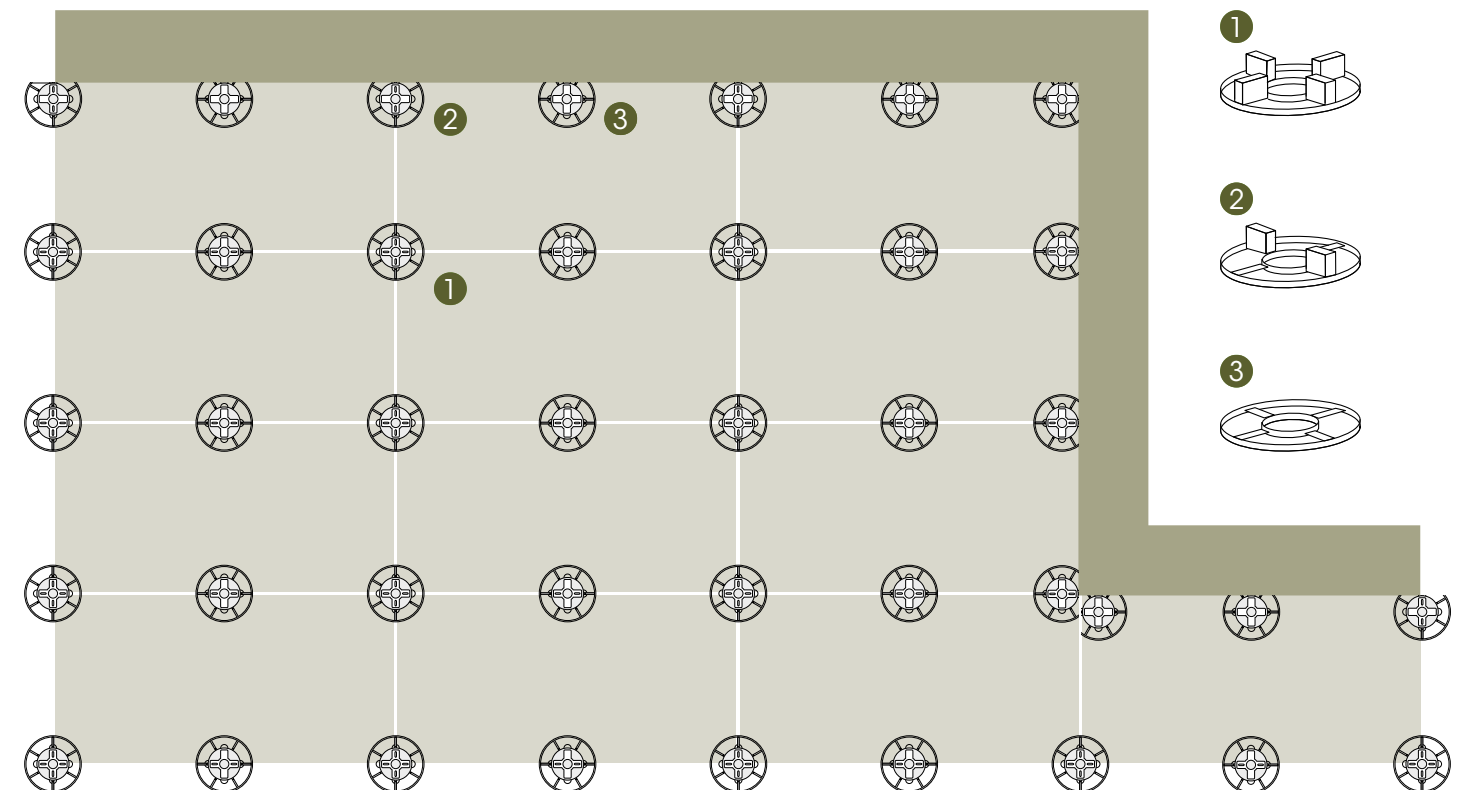
DIE ANZAHL DER TRÄGER PRO STÜCK UND PRO QUADRATMETER VARIERT JE NACH DER ZU VERLEGENDEN FLÄCHE. EINE GRÖßERE SEITENLÄNGE DER PLATTEN BESTIMMT ALSO EINE HÖHERE ANZAHL AN TRÄGERN PRO QUADRATMETER.

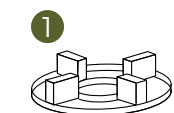
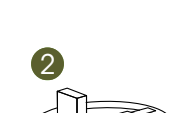

- 1 
- 2 
- 3 

LA SOLUZIONE IDEALE PER L'ALZATA

THE IDEAL SOLUTION FOR HEIGHT - LA SOLUTION IDÉALE POUR LA HAUTEUR DE MARCHÉ - DIE IDEALE LÖSUNG FÜR DIE STUFENHÖHE



CLIP BORDO VERTICALE TESTA
UPPER VERTICAL CLIP
CLIP BORD VERTICAL TÊTE
CLIP VERTIKALER RAND KOPFSTÜCK

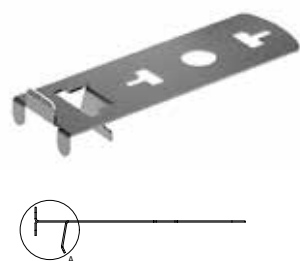

CLIP BORDO VERTICALE BASE
LOWER VERTICAL CLIP
CLIP BORD VERTICAL BASE
CLIP VERTIKALER RAND UNTERBAU



L'ESIGENZA DI AVERE UN'ALZATA IN CONTINUITÀ ESTETICA CON LA PAVIMENTAZIONE ANCHE IN MANCANZA DI UN SUPPORTO VERTICALE CONTINUO ORA PUÒ ESSERE SODDISFATTA GRAZIE ALLE CLIPS BORDO VERTICALE. L'INNOVATIVO SISTEMA PUÒ ESSERE UTILIZZATO PER CHIUDERE PERIMETRALMENTE LO SPAZIO CHE VIENE A FORMARSI QUANDO SI INSTALLA UN PAVIMENTO SOPRAELEVATO. LE DUE CLIPS SONO IN ACCIAIO INOX E VENGONO POSIZIONATE UNA IN TESTA E UNA ALLA BASE DEL SUPPORTO PERMETTENDO DI FISSARE LE PIASTRELLE VERTICALI IN COMPLETA SICUREZZA E CON ASSOLUTA ELEGANZA. INOLTRE, LA CLIP IN TESTA AL SUPPORTO POSSIEDE UN PARTICOLARE BLOCCO CHE CONSENTE DI CONTRASTARE L'EVENTUALE SCIVOLAMENTO DELLE PIASTRELLE ORIZZONTALI.

THE NEED TO HAVE A RAISED SECTION WITH AESTHETIC CONTINUITY OF THE FLOORING ALSO IN THE ABSENCE OF A CONTINUOUS VERTICAL SUPPORT IS NOW POSSIBLE THANKS TO CLIPS FOR VERTICAL EDGING. THE INNOVATIVE SYSTEM CAN BE USED TO CLOSE PERIMETER SPACING WHICH FORMS WHEN A RAISED FLOOR IS INSTALLED. THE TWO CLIPS ARE IN STAINLESS STEEL AND ARE POSITIONED ONE ON TOP AND THE OTHER ON THE BOTTOM OF THE SUPPORT TO ENABLE FASTENING THE VERTICAL TILES IN A COMPLETELY SAFE AND ABSOLUTELY ELEGANT MANNER. FURTHERMORE, THE CLIP ON THE TOP OF THE SUPPORT HAS A PARTICULAR LOCK THAT COUNTERS ANY SLIPPING OF THE HORIZONTAL TILES.

L'EXIGENCE D'AVOIR UNE HAUTEUR DE MARCHÉ ESTHÉTIQUE AVEC LE PAVAGE MÊME EN MANQUE D'UN SUPPORT VERTICAL CONTINU PEUT DÉSORMAIS ÊTRE SATISFAITE GRÂCE AUX CLIPS BORD VERTICAL. LE SYSTÈME NOUVEAU PEUT ÊTRE UTILISÉ POUR FERMER, SUR LE PÉRIMÈTRE, L'ESPACE QUI VIENT À SE CRÉER LORSQU'ON INSTALLE UN PAVAGE SURÉLEVÉ. LES DEUX CLIPS SONT EN ACIER INOX ET SONT POSITIONNÉS UN EN TÊTE ET L'AUTRE À LA BASE DU SUPPORT, CE QUI PERMET DE FIXER LES CARREAUX VERTICAUX EN TOUTE SÉCURITÉ ET AVEC PARFAITE ÉLÉGANCE. DE PLUS, LE CLIP, EN TÊTE DE SUPPORT, POSSÈDE UN BLOC PARTICULIER PERMETTANT DE CONTRASTER TOUTE RISQUE DE GLISSEMENT DES CARREAUX HORIZONTAUX.

DER BEDARF EINE ÄSTHETISCHE KONTINUITÄT MIT DEM BODEN ZU ERHALTEN, AUCH WENN EIN KONTINUIERLICHER VERTIKALER TRÄGER FEHLT, KANN MIT DEN CLIPS AN DEN VERTIKALEN RÄNDERN GELÖST WERDEN. DAS INNOVATIVE SYSTEM KANN VERWENDET WERDEN, UM PERIMETRAL DEN RAUM ZU SCHLIESSEN, DER BEI DER INSTALLATION EINES ANGEHOBBENEN BODENS ENTSTEHT. DIE BEIDEN CLIPS SIND AUS EDELSTAHL WERDEN AN DEM KOPFTEIL UND EINER AN DER UNTERLAGE BEFESTIGT, UM DIE VERTIKALEN FLIESEN SICHER UND MIT EINEM ELEGANTEN ERSCHENUNGSBILD ZU BEFESTIGEN. DER CLIP AM KOPFSTÜCK BESITZT EINE BESONDERE SPERRE, MIT DER MAN EIN EVENTUELLES ABRUTSCHEN DER HORIZONTALEN FLIESEN VERHINDERT.



PER I PREZZI DEI SUPPORTI SI PREGA DI CONTATTARE GLI UFFICI COMMERCIALI, O ENGINEERING.
FOR THE PRICE OF THE MOUNTINGS, PLEASE CONTACT THE SALES, OR ENGINEERING OFFICE.
POUR LES TARIFS DES SUPPORTS, NOUS VOUS PRIONS DE BIEN VOULOIR CONTACTER LES SERVICES COMMERCIAUX, OU ENGINEERING.
FÜR PREISE DER UNTERLAGEN BITTE UNSERE VERTRIEBSBÜROS ODER ENGINEERINGKONTAKTIEREN.



L'ACCOSTAMENTO PERIMETRALE

PERIMETER APPROACH - MISE EN CONTACT PÉRIMÉTRALE - PERIMÉTRALE ANNÄHERUNG



CLIP BORDO PIASTRA
CLIPPED TILE
CLIP BORD PLAQUE
CLIP FLIESENRAND

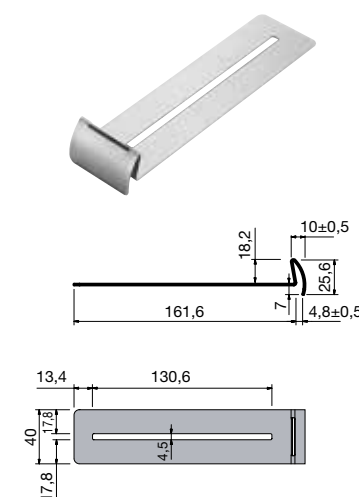

LA CLIP BORDO PIASTRA NASCE PER EVITARE IL CONTATTO DIRETTO TRA LA PIASTRELLA E IL MURO PERIMETRALE NELLE PAVIMENTAZIONI SOPRAELEVATE DA ESTERNO. LA CLIP È REALIZZATA IN ACCIAIO INOX, È PENSATA PER FORNIRE MAGGIORE STABILITÀ ALLA PAVIMENTAZIONE E PER AMMORTIZZARE LE DILATAZIONI, ASSICURANDO UNA FUGA PERIMETRALE FUNZIONALE ED ELEGANTE.

THE CLIPPED TILE CAME ABOUT TO AVOID DIRECT CONTACT BETWEEN THE TILE AND THE PERIMETER WALL OF RAISED OUTDOOR FLOORING. THE CLIP IS CREATED IN STAINLESS STEEL, DESIGNED TO PROVIDE GREATER STABILITY OF FLOORING AND REDUCE DILATION, ENSURING A FUNCTIONAL AND ELEGANT PERIMETER JOINT.

LE CLIP BORD PLAQUE A ÉTÉ CONÇU POUR ÉVITER LE CONTACT DIRECT ENTRE LE CARREAU ET LE MUR PÉRIMÉTRAL DANS LE CADRE DE PAVAGES SURÉLEVÉS D'EXTÉRIEUR. LE CLIP EST RÉALISÉ EN ACIER INOX ET CONÇU POUR FOURNIR D'AVANTAGE DE STABILITÉ AU PAVAGE ET POUR AMORTIR LES DILATATIONS, EN ASSURANT UNE FUGUE PÉRIMÉTRALE FONCTIONNELLE ET ÉLÉGANTE.

DER CLIP AM FLIESENRAND SOLL DEN DIREKTEN KONTAKT ZWISCHEN DER FLIESE UND DER UMLIEGENDEN WAND BEI ANGEHOBBENEN BÖDEN FÜR DEN AUSSENBEREICH VERMEIDEN. DER CLIP IST AUS EDELSTAHL GEFERTIGT, SOLL DEM BODEN EINE ERHÖHTE STABILITÄT GARANTIEREN, AUSDEHNUNGEN ABSCHWÄCHEN UND EINE FUNKTIONALE UND ELEGANTE PERIMETRALFUGE SICHERN.

Ambiente realizzato con: - Setting realized with:
Ambiance réalisée avec: - Fotos mit:

TITAN_CEMENT

80x80 - 31,5"x31,5" grip

20 mm

TWO 20 MM

POOLS&WELLNESS



TWO POOLS & WELLNESS

20 MM

PEZZI SPECIALI PISCINA CENTURY

Century Pools Special Pieces - Pièces Spéciales Century - Century Formstücke

SERIE COMPLETA - FULL RANGE - GAMME COMPLÈTE - KOMPLETTE SERIE

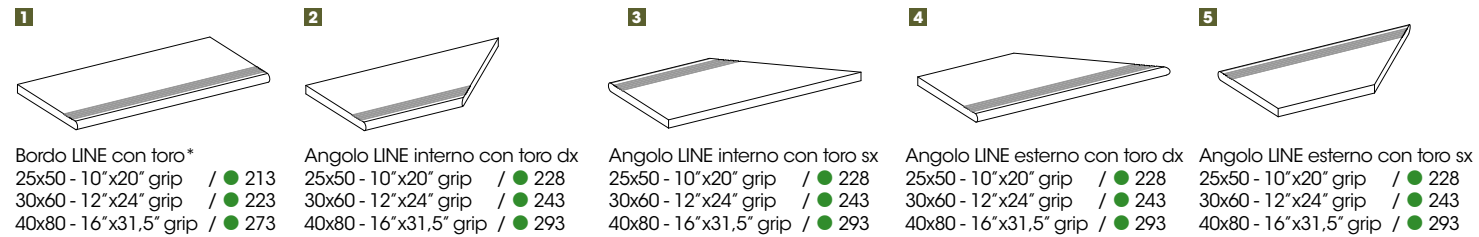

1 Bordo LINE con toro*
25x50 - 10"x20" grip / ● 213
30x60 - 12"x24" grip / ● 223
40x80 - 16"x31,5" grip / ● 273

2 Angolo LINE interno con toro dx
25x50 - 10"x20" grip / ● 228
30x60 - 12"x24" grip / ● 243
40x80 - 16"x31,5" grip / ● 293

3 Angolo LINE interno con toro sx
25x50 - 10"x20" grip / ● 228
30x60 - 12"x24" grip / ● 243
40x80 - 16"x31,5" grip / ● 293

4 Angolo LINE esterno con toro dx
25x50 - 10"x20" grip / ● 228
30x60 - 12"x24" grip / ● 243
40x80 - 16"x31,5" grip / ● 293

5 Angolo LINE esterno con toro sx
25x50 - 10"x20" grip / ● 228
30x60 - 12"x24" grip / ● 243
40x80 - 16"x31,5" grip / ● 293

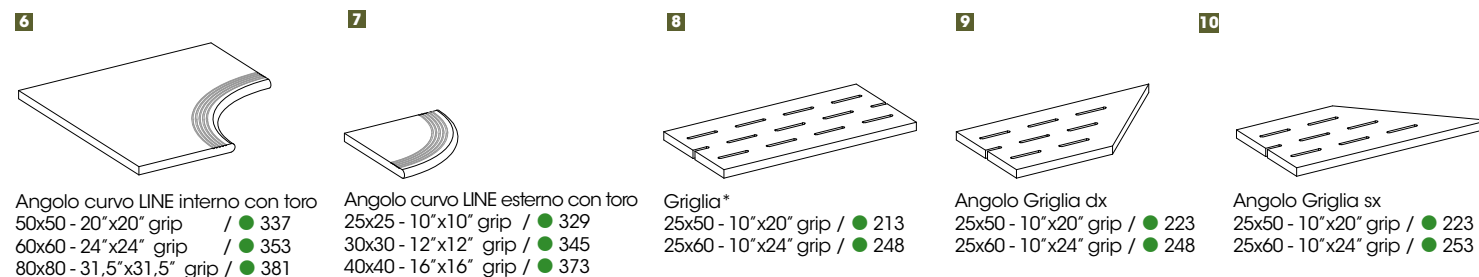

6 Angolo curvo LINE interno con toro
50x50 - 20"x20" grip / ● 337
60x60 - 24"x24" grip / ● 353
80x80 - 31,5"x31,5" grip / ● 381

7 Angolo curvo LINE esterno con toro
25x25 - 10"x10" grip / ● 329
30x30 - 12"x12" grip / ● 345
40x40 - 16"x16" grip / ● 373

8 Griglia*
25x50 - 10"x20" grip / ● 213
25x60 - 10"x24" grip / ● 248

9 Angolo Griglia dx
25x50 - 10"x20" grip / ● 223
25x60 - 10"x24" grip / ● 248

10 Angolo Griglia sx
25x50 - 10"x20" grip / ● 223
25x60 - 10"x24" grip / ● 248

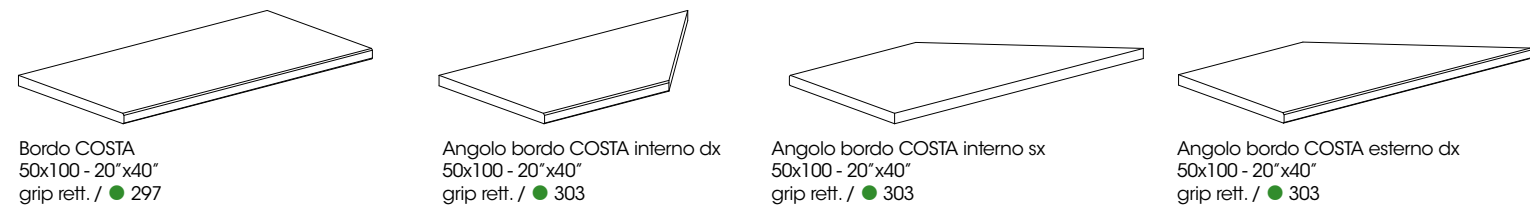

11 Bordo COSTA
50x100 - 20"x40" grip rett. / ● 297

12 Angolo bordo COSTA interno dx
50x100 - 20"x40" grip rett. / ● 303

13 Angolo bordo COSTA interno sx
50x100 - 20"x40" grip rett. / ● 303

14 Angolo bordo COSTA esterno dx
50x100 - 20"x40" grip rett. / ● 303

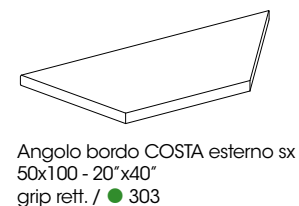

15 Angolo bordo COSTA esterno sx
50x100 - 20"x40" grip rett. / ● 303

ESEMPI DI PEZZI SPECIALI DA ABBINARE AL SISTEMA A SFIORO (FINLANDESE)

SPECIAL PIECES EXAMPLES MATCHED WITH THE INFINITY (OR FINNISH) SYSTEM
EXEMPLES DES PIÈCES SPÉCIALES À ASSOCIER AU SYSTÈME À DÉVERSOIR (FINLANDAIS)
FORMSTÜCKE BEISPIELEN FÜR DIE VERWENDUNG MIT ÜBERLAUF-SYSTEMEN (FINNISCH)

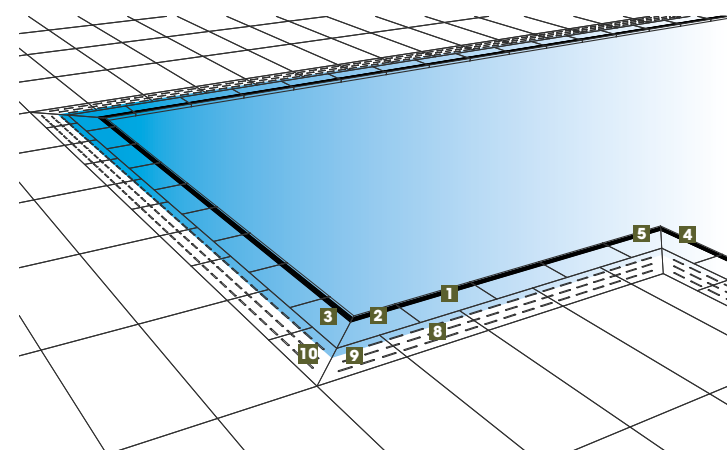

ESEMPI DI PEZZI SPECIALI DA ABBINARE AL SISTEMA A "SKIMMER"

SPECIAL PIECES EXAMPLES MATCHED WITH THE "SKIMMER" SYSTEM
EXEMPLES DES PIÈCES SPÉCIALES À ASSOCIER AU SYSTÈME À "SKIMMER"
FORMSTÜCKE BEISPIELEN FÜR DIE VERWENDUNG MIT "SKIMMER"-SYSTEMEN

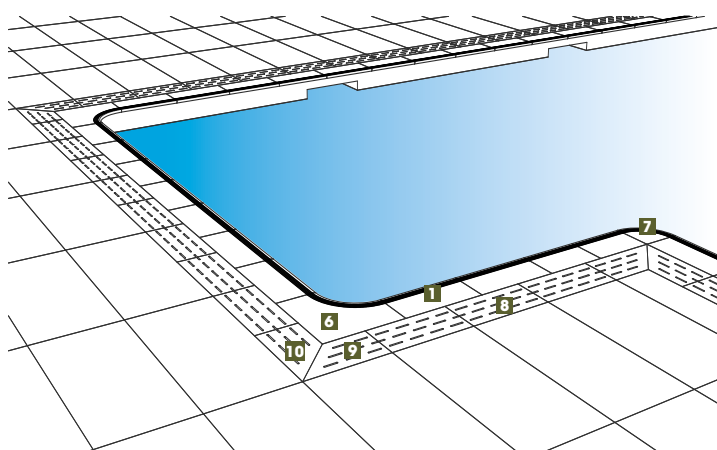

TWO POOLS & WELLNESS

20 MM

PEZZI SPECIALI PISCINA CENTURY

Century Pools Special Pieces - Pièces Spéciales Century - Century Formstücke

SERIE COMPLETA - FULL RANGE - GAMME COMPLÈTE - KOMPLETTE SERIE

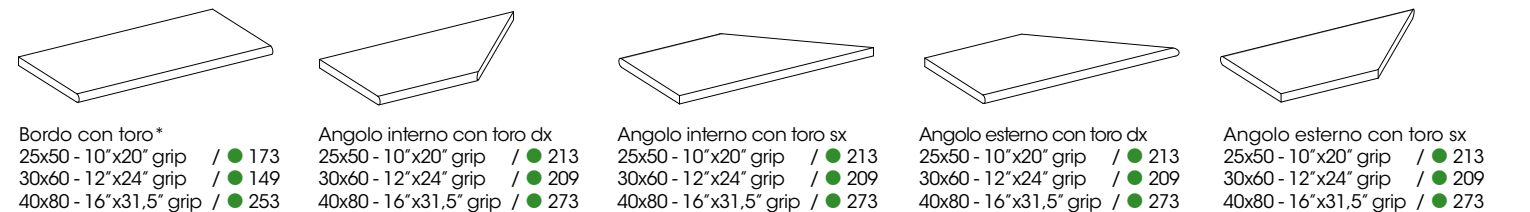

1 Bordo con toro*
25x50 - 10"x20" grip / ● 173
30x60 - 12"x24" grip / ● 149
40x80 - 16"x31,5" grip / ● 253

2 Angolo interno con toro dx
25x50 - 10"x20" grip / ● 213
30x60 - 12"x24" grip / ● 209
40x80 - 16"x31,5" grip / ● 273

3 Angolo interno con toro sx
25x50 - 10"x20" grip / ● 213
30x60 - 12"x24" grip / ● 209
40x80 - 16"x31,5" grip / ● 273

4 Angolo esterno con toro dx
25x50 - 10"x20" grip / ● 213
30x60 - 12"x24" grip / ● 209
40x80 - 16"x31,5" grip / ● 273

5 Angolo esterno con toro sx
25x50 - 10"x20" grip / ● 213
30x60 - 12"x24" grip / ● 209
40x80 - 16"x31,5" grip / ● 273

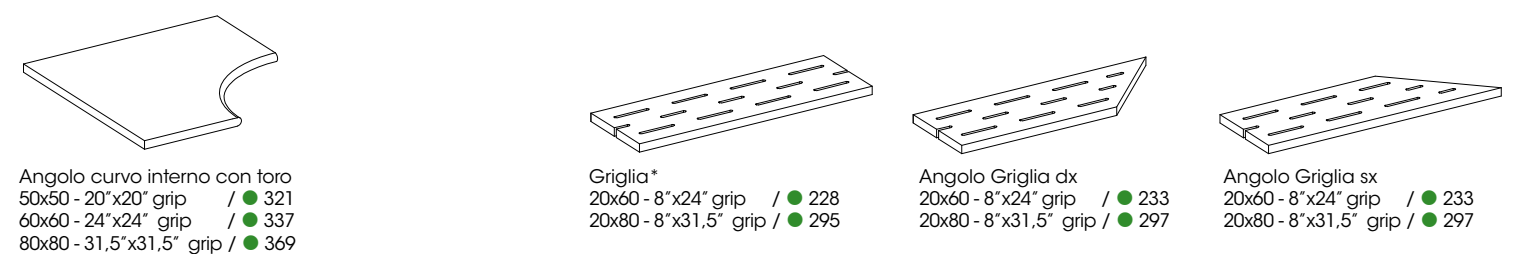

6 Angolo curvo interno con toro
50x50 - 20"x20" grip / ● 321
60x60 - 24"x24" grip / ● 337
80x80 - 31,5"x31,5" grip / ● 369

7 Griglia*
20x60 - 8"x24" grip / ● 228
20x80 - 8"x31,5" grip / ● 295

8 Angolo Griglia dx
20x60 - 8"x24" grip / ● 233
20x80 - 8"x31,5" grip / ● 297

9 Angolo Griglia sx
20x60 - 8"x24" grip / ● 233
20x80 - 8"x31,5" grip / ● 297

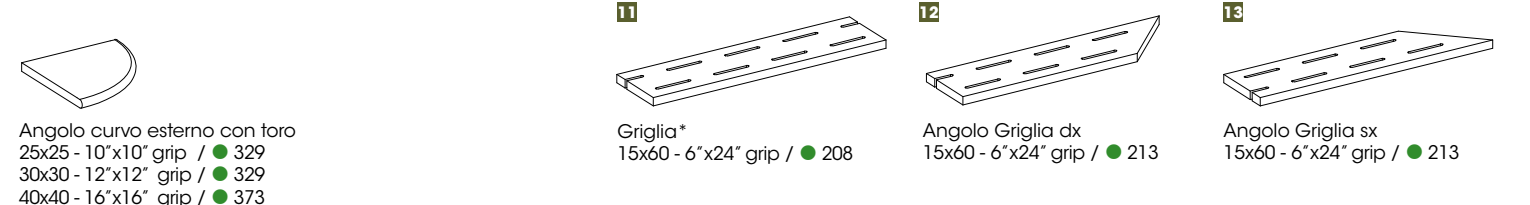

11 Angolo curvo esterno con toro
25x25 - 10"x10" grip / ● 329
30x30 - 12"x12" grip / ● 329
40x40 - 16"x16" grip / ● 373

12 Griglia*
15x60 - 6"x24" grip / ● 208

13 Angolo Griglia dx
15x60 - 6"x24" grip / ● 213

14 Angolo Griglia sx
15x60 - 6"x24" grip / ● 213

* Prezzo per ordine minimo di 20 pezzi. Per quantitativi inferiori, rivolgersi agli uffici commerciali per una quotazione specifica.
Price for a minimum order of 20 items. For smaller volumes, please contact our commercial office for a specific quote.

ESEMPI DI PEZZI SPECIALI DA ABBINARE AL SISTEMA A SFIORO (FINLANDESE)

SPECIAL PIECES EXAMPLES MATCHED WITH THE INFINITY (OR FINNISH) SYSTEM
EXEMPLES DES PIÈCES SPÉCIALES À ASSOCIER AU SYSTÈME À DÉVERSOIR (FINLANDAIS)
FORMSTÜCKE BEISPIELEN FÜR DIE VERWENDUNG MIT ÜBERLAUF-SYSTEMEN (FINNISCH)

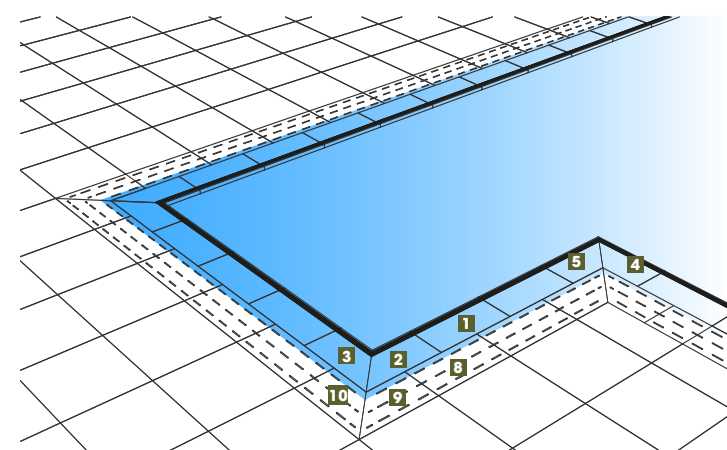

ESEMPI DI PEZZI SPECIALI DA ABBINARE AL SISTEMA A "SKIMMER"

SPECIAL PIECES EXAMPLES MATCHED WITH THE "SKIMMER" SYSTEM
EXEMPLES DES PIÈCES SPÉCIALES À ASSOCIER AU SYSTÈME À « SKIMMER »
FORMSTÜCKE BEISPIELEN FÜR DIE VERWENDUNG MIT "SKIMMER"-SYSTEMEN

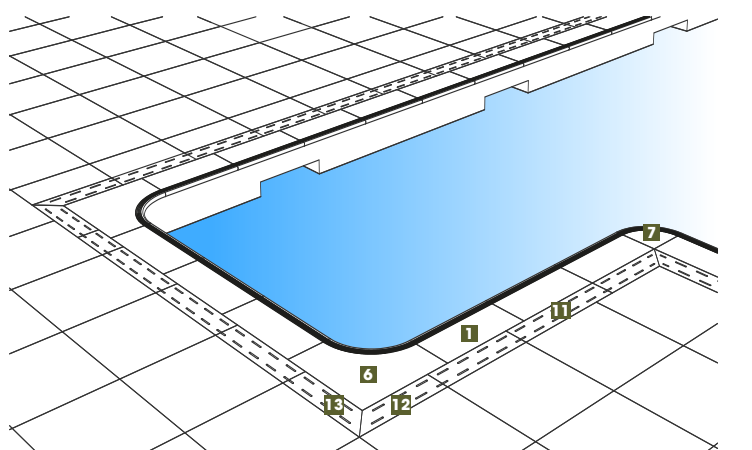

COLORI E PEZZI SPECIALI

TWO

Colours and special pieces - Couleurs et Pièces spéciales - Farben und Formstücke

ELEMENT



80x80 - 31,5"x31,5"
137251 grip rett. / ■ 157

REACTION



OXYGEN



80x80 - 31,5"x31,5"
137250 grip rett. / ■ 157

TRACE



80x80 - 31,5"x31,5"
137832 grip rett. / ■ 157

MUSEUM



80x80 - 31,5"x31,5"
137833 grip rett. / ■ 157

EBUR



50x100 - 20"x40"
130018 grip rett. / ■ 151 | 130017 grip / ■ 133

Aurum



PEZZI SPECIALI - SPECIAL PIECES - PIÈCES SPÉCIALES - FORMSTÜCKE

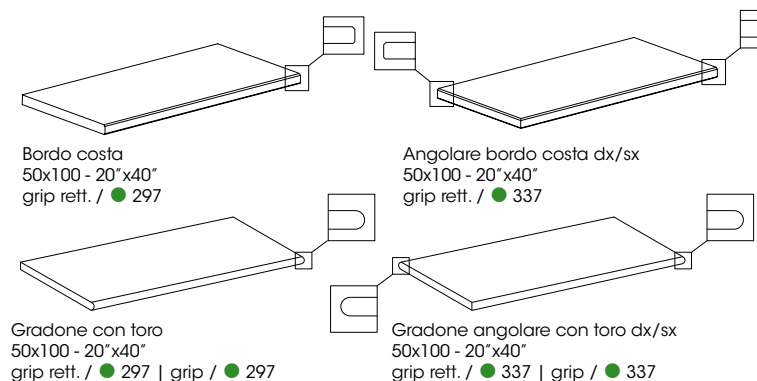

Bordo costa
50x100 - 20"x40"
grip rett. / ● 297

Angolare bordo costa dx/sx
50x100 - 20"x40"
grip rett. / ● 337

Gradone con toro
50x100 - 20"x40"
grip rett. / ● 297 | grip / ● 297

Gradone angolare con toro dx/sx
50x100 - 20"x40"
grip rett. / ● 337 | grip / ● 337

Imballi - Packaging - Emballages - Verpackungen

Formato - Size Format - Größe	PC.	m ²	Nat. Kg	Rett. Kg
50x100	1	0,5	22,5	22
Formato - Size Format - Größe	PC.	m ²	Nat. Kg	Rett. Kg
50x100	42	21	945	924

PEZZI SPECIALI - SPECIAL PIECES - PIÈCES SPÉCIALES - FORMSTÜCKE

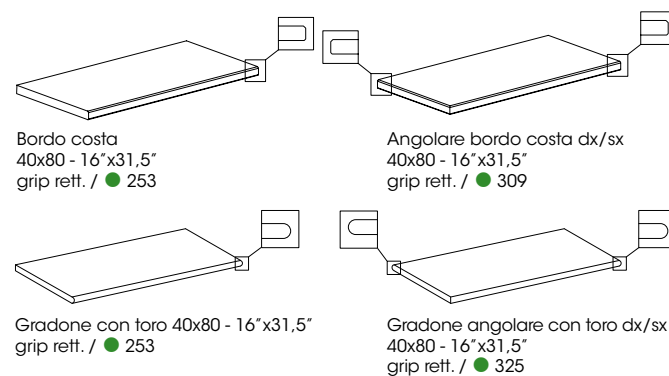

Bordo costa
40x80 - 16"x31,5"
grip rett. / ● 253

Angolare bordo costa dx/sx
40x80 - 16"x31,5"
grip rett. / ● 309

Gradone con toro 40x80 - 16"x31,5"
grip rett. / ● 253

Gradone angolare con toro dx/sx
40x80 - 16"x31,5"
grip rett. / ● 325

Imballi - Packaging - Emballages - Verpackungen

Formato - Size Format - Größe	PC.	m ²	Nat. Kg	Rett. Kg
80x80	1	0,64	-	29
Formato - Size Format - Größe	PC.	m ²	Nat. Kg	Rett. Kg
80x80	40	25,6	-	1160

VOGUE



80x80 - 31,5"x31,5"
130159 grip rett. / ■ 157

PEZZI SPECIALI - SPECIAL PIECES - PIÈCES SPÉCIALES - FORMSTÜCKE

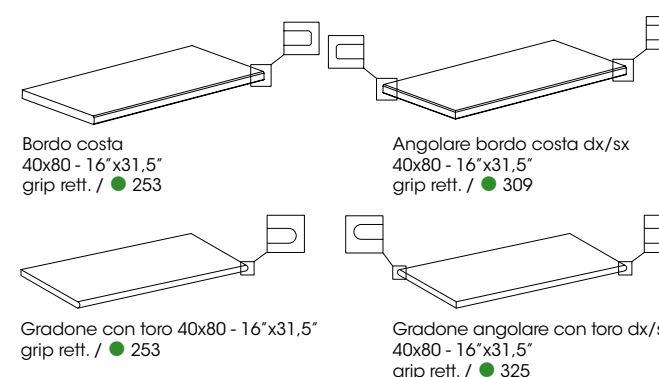

Bordo costa
40x80 - 16"x31,5"
grip rett. / ● 253

Angolare bordo costa dx/sx
40x80 - 16"x31,5"
grip rett. / ● 309

Gradone con toro 40x80 - 16"x31,5"
grip rett. / ● 253

Gradone angolare con toro dx/sx
40x80 - 16"x31,5"
grip rett. / ● 325

Imballi - Packaging - Emballages - Verpackungen

Formato - Size Format - Größe	PC.	m ²	Nat. Kg	Rett. Kg
80x80	1	0,64	-	29
Formato - Size Format - Größe	PC.	m ²	Nat. Kg	Rett. Kg
80x80	40	25,6	-	1160

CONTACT



GEOLOGY

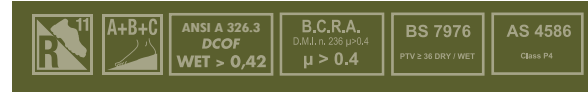

MINERAL



50x100 - 20"x40" 129073 grip rett. / ■ 151 | 128657 grip / ■ 133

MARS



50x100 - 20"x40" 129071 grip rett. / ■ 151 | 128658 grip / ■ 133

FOSSIL



50x100 - 20"x40" 129072 grip rett. / ■ 151 | 128659 grip / ■ 133

HABITAT



50x100 - 20"x40" 129074 grip rett. / ■ 151

PEZZI SPECIALI - SPECIAL PIECES - PIÈCES SPÉCIALES - FORMSTÜCKE

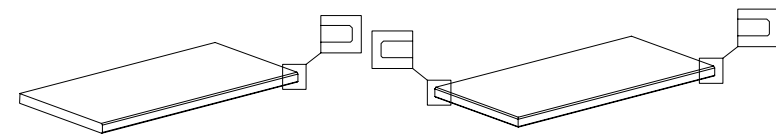

Bordo costa
50x100 - 20"x40"
grip rett. / ● 297

Angolare bordo costa dx/sx
50x100 - 20"x40"
grip rett. / ● 337

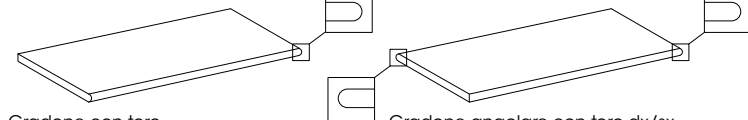

Gradone con toro
50x100 - 20"x40"
grip rett. / ● 297 | grip / ● 297

Gradone angolare con toro dx/sx
50x100 - 20"x40"
grip rett. / ● 337 | grip / ● 337

Imballi - Packaging - Emballages - Verpackungen

Formato - Size Format - Größe	PC.	m ²	Nat. Kg	Rett. Kg
50x100	1	0,5	22,5	22

Formato - Size Format - Größe	PC.	m ²	Nat. Kg	Rett. Kg
50x100	42	21	945	924

GLAM



GLAM BEIGE



80x80 - 31,5"x31,5"
113144 grip rett. / ■ 157

GLAM GRIGIO



80x80 - 31,5"x31,5"
113143 grip rett. / ■ 157

GLAM TORTORA



80x80 - 31,5"x31,5"
113142 grip rett. / ■ 157

PEZZI SPECIALI - SPECIAL PIECES - PIÈCES SPÉCIALES - FORMSTÜCKE

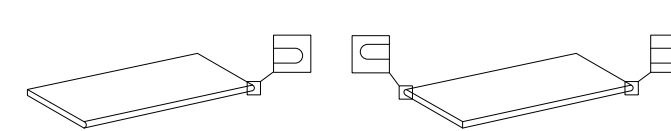

Gradone con toro 40x80 - 16"x31,5"
grip rett. / ● 253

Gradone angolare con toro dx/sx 40x80 - 16"x31,5"
grip rett. / ● 325

Imballi - Packaging - Emballages - Verpackungen

Formato - Size Format - Größe	PC.	m ²	Nat. Kg	Rett. Kg
80x80	1	0,64	-	29

Formato - Size Format - Größe	PC.	m ²	Nat. Kg	Rett. Kg
80x80	40	25,6	-	1160

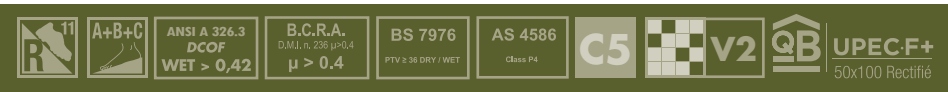

CASTLE STONE



50x100 - 20"x40" 101382 grip rett. / ■ 151 | 101377 grip / ■ 133



80x80 - 31,5"x31,5" 107680 grip rett. / ■ 157

DARK STONE



50x100 - 20"x40" 101383 grip rett. / ■ 151 | 101378 grip / ■ 133

LIME STONE



50x100 - 20"x40" 101384 grip rett. / ■ 151 | 101379 grip / ■ 133

PEZZI SPECIALI - SPECIAL PIECES - PIÈCES SPÉCIALES - FORMSTÜCKE

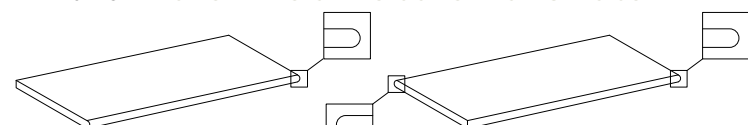

Gradone con toro 50x100 - 20"x40" grip rett. / ● 297 | grip / ● 297



Gradone angolare con toro dx/sx 50x100 - 20"x40" grip rett. / ● 337 | grip / ● 337

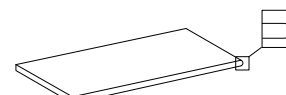

Gradone con toro 40x80 - 16"x31,5" grip rett. / ● 253



Gradone angolare con toro dx/sx 40x80 - 16"x31,5" grip rett. / ● 325

Imballi - Packaging - Emballages - Verpackungen

Formato - Size Format - Größe	PC.	m ²	Nat. Kg	Ref. Kg
50x100	1	0,5	22,5	22
80x80	1	0,64	-	29

Formato - Size Format - Größe	PC.	m ²	Nat. Kg	Ref. Kg
50x100	42	21	945	924
80x80	40	25,6	-	1160

WHITE STONE



50x100 - 20"x40" 119806 grip rett. / ■ 151 119812 grip / ■ 133

LIGHT STONE



50x100 - 20"x40" 119805 grip rett. / ■ 151 | 119811 grip / ■ 133

ASH STONE



50x100 - 20"x40" 119808 grip rett. / ■ 151 | 119814 grip / ■ 133

RUST STONE



50x100 - 20"x40" 119807 grip rett. / ■ 151 | 119813 grip / ■ 133

BLACK STONE



50x100 - 20"x40" 119804 grip rett. / ■ 151 | 119810 grip / ■ 133

PEZZI SPECIALI - SPECIAL PIECES - PIÈCES SPÉCIALES - FORMSTÜCKE

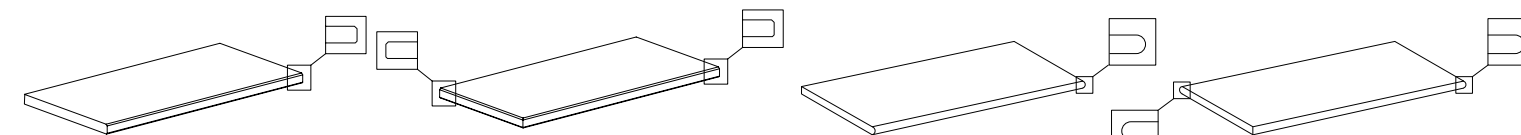

Bordo costa 50x100 - 20"x40" grip rett. / ● 297

Angolare bordo costa dx/sx 50x100 - 20"x40" grip rett. / ● 337

Gradone con toro 50x100 - 20"x40" grip rett. / ● 297 | grip / ● 297

Gradone angolare con toro dx/sx 50x100 - 20"x40" grip rett. / ● 337 | grip / ● 337

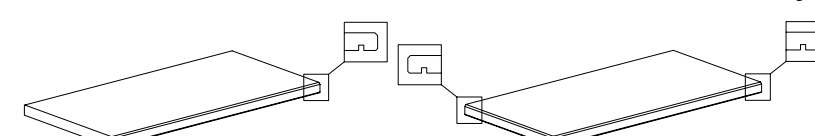

Bordo costa con gocciolatoio 50x100 - 20"x40" grip rett. / ● 305

Angolare bordo costa con gocciolatoio dx/sx 50x100 - 20"x40" grip rett. / ● 349

Imballi - Packaging - Emballages - Verpackungen

Formato - Size Format - Größe	PC.	m ²	Nat. Kg	Ref. Kg
50x100	1	0,5	22,5	22

Formato - Size Format - Größe	PC.	m ²	Nat. Kg	Ref. Kg
50x100	42	21	945	924

UPTOWN



HAMILTON



50x100 - 20"x40"
94560 grip rett. / ■151 | 94559 grip / ■133

MORNINGSIDE



50x100 - 20"x40"
94574 grip rett. / ■151 | 94573 grip / ■133

HUDSON



50x100 - 20"x40"
94576 grip rett. / ■151 | 94575 grip / ■133



80x80 - 31,5"x31,5" 60x60 - 24"x24"
107832 grip rett. / ■157 107307 grip / ■133

PEZZI SPECIALI - SPECIAL PIECES - PIÈCES SPÉCIALES - FORMSTÜCKE

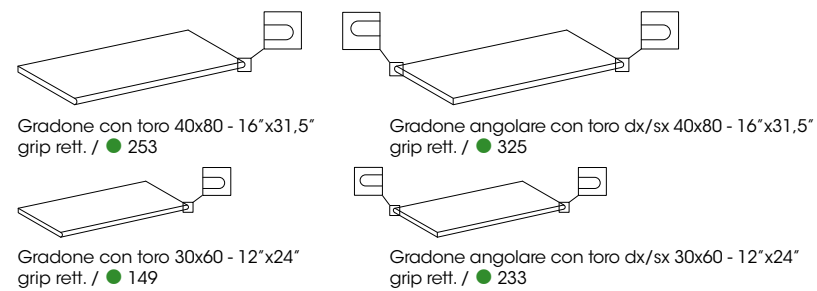
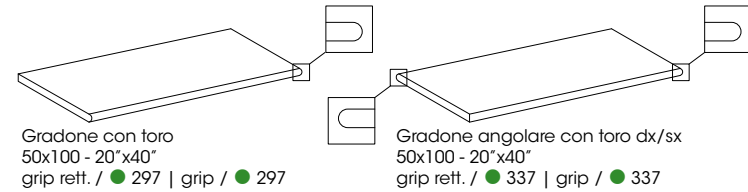

Imballi - Packaging - Emballages - Verpackungen

	Formato - Size Format - Größe	PC.	m ²	Nat. Kg	Rett. Kg
	50x100	1	0,5	22,5	22
	80x80	1	0,64	-	29
	60x60	2	0,72	-	32,75

	Formato - Size Format - Größe	PC.	m ²	Nat. Kg	Rett. Kg
	50x100	42	21	945	924
	80x80	40	25,6	-	1160
	60x60	30	21,6	-	980

TITAN

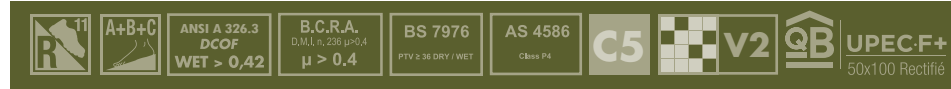

CORTEN



50x100 - 20"x40"
113726 grip rett. / ■151 | 113722 grip / ■133

PLATINUM



50x100 - 20"x40"
113740 grip rett. / ■151 | 113724 grip / ■133

CEMENT



80x80 - 31,5"x31,5"
107685 grip rett. / ■157

60x60 - 24"x24"
107295 grip rett. / ■133

PEZZI SPECIALI - SPECIAL PIECES - PIÈCES SPÉCIALES - FORMSTÜCKE

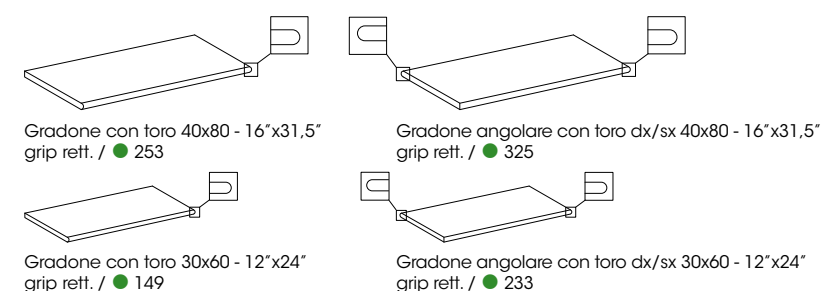
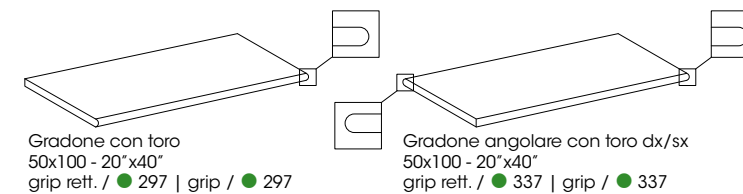

Imballi - Packaging - Emballages - Verpackungen

	Formato - Size Format - Größe	PC.	m ²	Nat. Kg	Rett. Kg
	50x100	1	0,5	22,5	22
	80x80	1	0,64	-	29
	60x60	2	0,72	-	32,75

	Formato - Size Format - Größe	PC.	m ²	Nat. Kg	Rett. Kg
	50x100	42	21	945	924
	80x80	40	25,6	-	1160
	60x60	30	21,6	-	980

FUSION

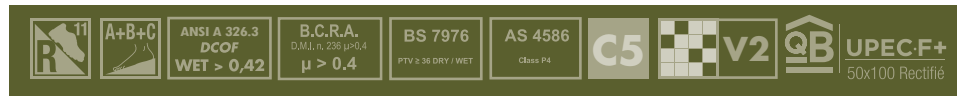

FUSION GREY



50x100 - 20"x40"
113776 grip rett. / ■ 151

TWO.0

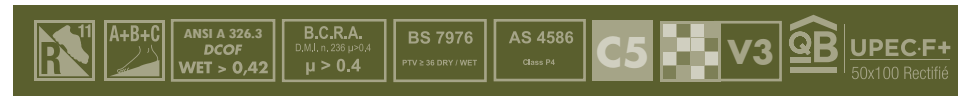

DESERT



50x100 - 20"x40"
93932 grip rett. / ■ 151 | 93524 grip / ■ 133



80x80 - 31,5"x31,5"
107831 grip rett. / ■ 157

60x60 - 24"x24"
76791 grip rett. / ■ 133

FOREST



60x60 - 24"x24"
76793 grip rett. / ■ 133

PEZZI SPECIALI - SPECIAL PIECES - PIÈCES SPÉCIALES - FORMSTÜCKE

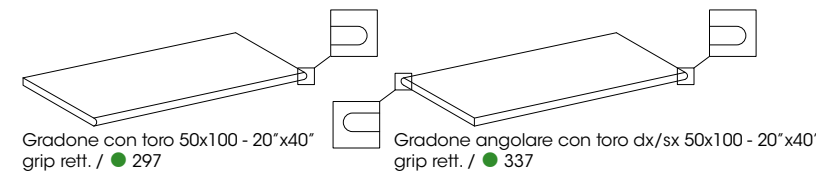

Gradone con toro 50x100 - 20"x40"
grip rett. / ● 297

Gradone angolare con toro dx/sx 50x100 - 20"x40"
grip rett. / ● 337

Imballi - Packaging - Emballages - Verpackungen

Formato - Size Format - Größe	PC.	m ²	Rett. Kg
50x100	1	0,5	22
50x100	42	21	924

PEZZI SPECIALI - SPECIAL PIECES - PIÈCES SPÉCIALES - FORMSTÜCKE

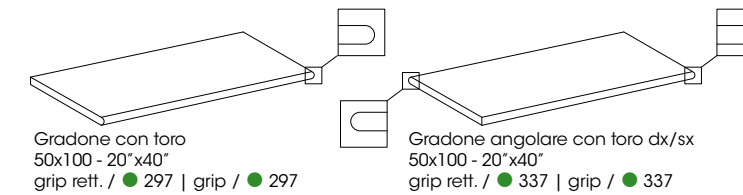

Gradone con toro
50x100 - 20"x40"
grip rett. / ● 297 | grip / ● 297

Gradone angolare con toro dx/sx
50x100 - 20"x40"
grip rett. / ● 337 | grip / ● 337

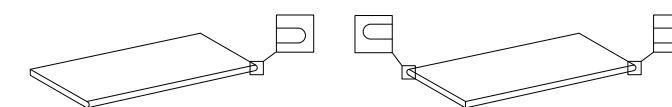

Gradone con toro 40x80 - 16"x31,5"
grip rett. / ● 253

Gradone angolare con toro dx/sx 40x80 - 16"x31,5"
grip rett. / ● 325

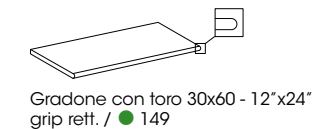

Gradone con toro 30x60 - 12"x24"
grip rett. / ● 149

Gradone angolare con toro dx/sx 30x60 - 12"x24"
grip rett. / ● 233

Imballi - Packaging - Emballages - Verpackungen

Formato - Size Format - Größe	PC.	m ²	Nat. Kg	Rett. Kg
50x100	1	0,5	22,5	22
80x80	1	0,64	-	29
60x60	2	0,72	-	32,75
Formato - Size Format - Größe	PC.	m ²	Nat. Kg	Rett. Kg
50x100	42	21	945	924
80x80	40	25,6	-	1160
60x60	30	21,6	-	980

CARATTERISTICHE TECNICHE / GRES FINE PORCELLANATO COLORATO IN MASSA
 TECHNICAL SPECIFICATIONS / COLOURED PORCELAIN STONEWARE - TECHNISCHE EIGENSCHAFTEN / DURCHGEFÄRBTES FEINSTEINZEUG
 CARACTÉRISTIQUES TECHNIQUES / GRÈS FIN CÉRAMÉ COLORÉ EN MASSE - CARACTERÍSTICAS TÉCNICAS /
 GRES FINO PORCELÁNICO TEÑIDO EN MASA - ТЕХНИЧЕСКИЕ ХАРАКТЕРИСТИКИ / МЕЛКОЗЕРНИСТЫЙ КЕРАМОГРАНИТ, ОКРАШЕННЫЙ В МАССЕ
 STANDARDS : UNI EN 14411 ANNEX G - Bia / UNI EN ISO 13006 ANNEX G - Bia



CARATTERISTICHE TECNICHE TECHNICAL DATA TECHNISCHE DATEN CARACTÉRISTIQUES TECHNIQUES CARACTERÍSTICAS TÉCNICAS ТЕХНИЧЕСКИЕ ХАРАКТЕРИСТИКИ		TIPO DI PROVA STANDARD OF TEST NORME DU TEST TESTNORM TIPO DE PRUEBA ТИП ТЕСТА	VALORI PRESCRITTI DALLE NORME INTERNATIONAL STANDARDS INTERNATIONALE NORMWERTE VALEURS PREVUES PAR LES NORMES VALORES PREVISTOS POR LAS NORMAS ПРЕДУСМОТРЕННЫЕ СТАНДАРТОМ			VALORE MEDIO AVERAGE VALUE MITTELWERT VALEURS MOYEN VALOR MEDIO СРЕДНЕЕ ЗНАЧЕНИЕ
CARATTERISTICHE DIMENSIONALI - SIZE CHARACTERISTICS MASSEIGENSCHAFTEN - DÉTERMINATION DES CARACTÉRISTIQUES DIMENSIONNELLES CARACTERÍSTICAS DIMENSIONALES - РАЗМЕРНЫЕ ХАРАКТЕРИСТИКИ			REQUIREMENTS FOR NOMINAL SIZE N			GRIP
			7 cm ≤ N < 15 cm	N ≥ 15 cm		
			mm	%	mm	
LATI - SIDES - SEITEN COTES - CANTOS РАЗМЕРЫ СТОРОН	FOR NON-RECTIFIED TILES	EN ISO 10545-2	± 0,9	± 0,6	± 2,0	CONFORME COMPLYING - ERFÜLLT CONFORME - CONFORME COOTBETCTBYET
	FOR RECTIFIED TILES		± 0,4	± 0,3	± 1,0	
SPESSORE THICKNESS - DICKE ÉPAISSEUR - ESPESOR ТОЛЩИНА		EN ISO 10545-2	± 0,5	± 5,0	± 0,5	CONFORME COMPLYING - ERFÜLLT CONFORME - CONFORME COOTBETCTBYET
RETTILINEITÀ DEGLI SPIGOLI STRAIGHTNESS OF SIDES - GERADLINIGKEIT DER KANTEN RECTITUDE DES ARÊTES - RECTITUD DE LOS CANTOS КООРДИНАТНОСТЬ	FOR NON-RECTIFIED TILES	EN ISO 10545-2	± 0,8	± 0,5	± 1,5	CONFORME COMPLYING - ERFÜLLT CONFORME - CONFORME COOTBETCTBYET
	FOR RECTIFIED TILES		± 0,4	± 0,3	± 0,8	
ORTOGONALITÀ RECTANGULARITY - RECHTWINKLIGKEIT PERPENDICULARITÉ - ORTOGONALIDAD КРИВИЗНА СТОРОН	FOR NON-RECTIFIED TILES	EN ISO 10545-2	± 0,8	± 0,5	± 2,0	CONFORME COMPLYING - ERFÜLLT CONFORME - CONFORME COOTBETCTBYET
	FOR RECTIFIED TILES		± 0,4	± 0,3	± 1,5	
PLANARITÀ SURFACE FLATNESS - EBENFLÄCHIGKEIT PLANEITE DE SURFACE - PLANEIDAD КРИВИЗНА ЛИЦЕВОЙ ПОВЕРХНОСТИ	CENTRE CURVATURE FOR NON-RECTIFIED TILES	EN ISO 10545-2	± 0,8	± 0,5	± 2,0	CONFORME COMPLYING - ERFÜLLT CONFORME - CONFORME COOTBETCTBYET
	FOR RECTIFIED TILES		± 0,6	± 0,4	± 1,8	
	EDGE CURVATURE FOR NON-RECTIFIED TILES		± 0,8	± 0,5	± 2,0	
	FOR RECTIFIED TILES		± 0,6	± 0,4	± 1,8	
	WARPAGE FOR RECTIFIED TILES		± 0,8	± 0,5	± 2,0	
ASSORBIMENTO D'ACQUA WATER ABSORPTION - WASSERAUFNAHME ABSORPTION D'EAU - ABSORCIÓN DE AGUA ВОДОПОГЛОЩЕНИЕ		EN ISO 10545-3	≤ 0,5%			≤ 0,1%
RESISTENZA ALLA FLESSIONE FLEXION RESISTANCE - BIEGEFESTIGKEIT RESISTANCE A LA FLEXION - RESISTENCIA A LA FLEXIÓN ПРЕДЕЛ ПРОЧНОСТИ ПРИ ИЗГИБЕ		EN ISO 10545-4	S ≥ 700 N < F7,5 mm			CONFORME COMPLYING - ERFÜLLT CONFORME - CONFORME COOTBETCTBYET
			S ≥ 1300 N ≥ F7,5 mm			
			R ≥ 35 N/mm ²			
RESISTENZA ALL'URTO IMPACT RESISTANCE - STOSSEFESTIGKEIT RESISTANCE AUX CHOCES - RESISTENCIA A LOS GOLPES УДАРНОСТОЙКОСТЬ		EN ISO 10545-5	VALORE DICHIARATO DECLARED VALUE - ANGEGBENER WERT VALEUR DÉCLARÉE - VALOR DECLARADO ЗАЯВЛЕННОЕ ЗНАЧЕНИЕ			> 0,80
COEFFICIENTE DI DILATAZIONE TERMICA LINEARE COEFFICIENT OF LINEAR THERMAL-EXPANSION - LINEARER WÄRMEAUDEHNUNGSKOEFFIZIENT COEFFICIENT DE DILATATION THERMIQUE LINEAIRE - COEFICIENTE DE DILATACIÓN TÉRMICA LINEAL - КОЭФФИЦИЕНТ ЛИНЕЙНОГО ТЕРМИЧЕСКОГО РАСШИРЕНИЯ		EN ISO 10545-8	VALORE DICHIARATO DECLARED VALUE - ANGEGBENER WERT VALEUR DÉCLARÉE - VALOR DECLARADO ЗАЯВЛЕННОЕ ЗНАЧЕНИЕ			$\alpha = 6,7 \times 10^{-6} / ^\circ C$
RESISTENZA AGLI SBALZI TERMICI RESISTANCE TO THERMAL SHOCKS - BESTÄNDIGKEIT GEGEN TEMPERATURSCHWANKUNGEN RESISTANCE AUX CHOCES THERMIQUES - RESISTENCIA A LOS CHOQUES TÉRMICOS СТОЙКОСТЬ К ПЕРЕПАДАМ ТЕМПЕРАТУРЫ		EN ISO 10545-9	TEST SUPERATO SECONDO EN ISO 10545-1 TEST PASSED ACCORDING TO - TEST BESTANDEN NACH TEXTE DÉPASSÉ SELON - PRUEBA SUPERADA SEGÚN ИСПЫТАНИЕ ПРОЙДЕНО В СООТВЕТСТВИИ С			NESSUN DANNO NO DAMAGE - KEIN SCHADEN AUCUN DOMMAGE - NINGUN DANO БЕЗ ПОВРЕЖДЕНИЙ
DILATAZIONE ALL'UMIDITÀ (IN MM/M) MOISTURE EXPANSION (IN MM/M) - FEUCHTIGKEITSBEDINGTE AUSDEHNUNG (IN MM/M) - DILATATION À L'HUMIDITÉ (EN MM/M) - DILATACIÓN CON LA HUMEDAD (EN MM/M) - ВЛАЖНОСТНОЕ РАСШИРЕНИЕ (В ММ/М)		EN ISO 10545-10	VALORE DICHIARATO DECLARED VALUE - ANGEGBENER WERT VALEUR DÉCLARÉE - VALOR DECLARADO ЗАЯВЛЕННОЕ ЗНАЧЕНИЕ			MAX 0,1 mm / m
RESISTENZA AL GELO FROST RESISTANCE - FROSTBESTÄNDIGKEIT - RESISTANCE AU GEL RESISTENCIA AL HIELO - МОРОЗОСТОЙКОСТЬ		EN ISO 10545-12	TEST SUPERATO SECONDO EN ISO 10545-1 TEST PASSED ACCORDING TO - TEST BESTANDEN NACH TEXTE DÉPASSÉ SELON - PRUEBA SUPERADA SEGÚN ИСПЫТАНИЕ ПРОЙДЕНО В СООТВЕТСТВИИ С			NESSUN DANNO NO DAMAGE - KEIN SCHADEN AUCUN DOMMAGE - NINGUN DANO БЕЗ ПОВРЕЖДЕНИЙ
RESISTENZA AI PRODOTTI CHIMICI USO DOMESTICO E ADDITIVI PER PISCINA RESISTANCE TO HOUSEHOLD AND SWIMMING POOL CHEMICAL PRODUCTS BESTÄNDIGKEIT GEGEN HAUSHALTSHEMIKALIEN UND ZUSATZSTOFFE FÜR SWIMMINGPOOLS - RESISTANCE AUX PRODUITS CHIMIQUES USAGE DOMESTIQUE ET ADDITIFS POUR PISCINE - RESISTENCIA A LOS PRODUCTOS QUÍMICOS DE USO DOMÉSTICO Y ADITIVOS PARA PISCINA - СТОЙКОСТЬ К ДЕЙСТВИЮ БЫТОВЫХ ХИМИЧЕСКИХ СРЕДСТВ, ДОБАВКАМ В БАССЕЙНЫ		EN ISO 10545-13	B MIN			CONFORME COMPLYING - ERFÜLLT CONFORME - CONFORME COOTBETCTBYET
RESISTENZA A BASSE CONCENTRAZIONI DI ACIDI E ALCALI RESISTANCE TO LOW CONCENTRATIONS OF ACIDS AND ALKALI - BESTÄNDIGKEIT BEI NIEDRIGEN KONZENTRATIONEN VON SÄUREN UND LAUGEN - RESISTANCE À BASSES CONCENTRATIONS D'ACIDES ET ALCALIS - RESISTENCIA A BAJAS CONCENTRACIONES DE ÁCIDOS Y ALCALIS - СТОЙКОСТЬ К ДЕЙСТВИЮ НИЗКИХ КОНЦЕНТРАЦИЙ КИСЛОТ И ЩЕЛОЧЕЙ		EN ISO 10545-13	VALORE DICHIARATO DECLARED VALUE - ANGEGBENER WERT VALEUR DÉCLARÉE - VALOR DECLARADO ЗАЯВЛЕННОЕ ЗНАЧЕНИЕ			CONFORME COMPLYING - ERFÜLLT CONFORME - CONFORME COOTBETCTBYET
RESISTENZA AD ALTE CONCENTRAZIONI DI ACIDI E ALCALI RESISTANCE TO HIGH CONCENTRATIONS OF ACIDS AND ALKALI - BESTÄNDIGKEIT BEI HOHEN KONZENTRATIONEN VON SÄUREN UND LAUGEN - RESISTANCE À HAUTES CONCENTRATIONS D'ACIDES ET ALCALIS - RESISTENCIA A ALTAS CONCENTRACIONES DE ÁCIDOS Y ALCALIS - СТОЙКОСТЬ К ДЕЙСТВИЮ ВЫСОКИХ КОНЦЕНТРАЦИЙ КИСЛОТ И ЩЕЛОЧЕЙ		EN ISO 10545-13	VALORE DICHIARATO DECLARED VALUE - ANGEGBENER WERT VALEUR DÉCLARÉE - VALOR DECLARADO ЗАЯВЛЕННОЕ ЗНАЧЕНИЕ			CONFORME COMPLYING - ERFÜLLT CONFORME - CONFORME COOTBETCTBYET
RESISTENZA ALLE MACCHIE RESISTANCE TO STAINS - FLECKENBESTÄNDIGKEIT RESISTANCE AUX TACHES - RESISTENCIA A LAS MANCHAS УСТОЙЧИВОСТЬ К ПЯТНООБРАЗОВАНИЮ		EN ISO 10545-14	VALORE DICHIARATO DECLARED VALUE - ANGEGBENER WERT VALEUR DÉCLARÉE - VALOR DECLARADO ЗАЯВЛЕННОЕ ЗНАЧЕНИЕ			CONFORME COMPLYING - ERFÜLLT CONFORME - CONFORME COOTBETCTBYET
CESSIONE DI PIOMBO E CADMIO LEAD AND CADMIUM DISCHARGE - ABGABE VON BLEI UND CADMIUM PÉRTE DE PLOMB ET CADMIUM - CESIÓN DE PLOMO Y CADMIO ВЫДЕЛЕНИЕ СВИНЦА И КАДМИЯ		EN ISO 10545-15	VALORE DICHIARATO DECLARED VALUE - ANGEGBENER WERT VALEUR DÉCLARÉE - VALOR DECLARADO ЗАЯВЛЕННОЕ ЗНАЧЕНИЕ			< AL LIMITE DI RILEVAMENTO < THAN INSTRUMENT LIMIT - UNMESSBARES WERT < LIMITE DE L'INSTRUMENT - LIMITE DEL INSTRUMENTO < НА ПРЕДЕЛЕ ОПРЕДЕЛИМОСТИ

TWO
NEW OUTDOOR FLOOR EXPERIENCE
20 MM
 FINE PORCELAIN STONEWARE

PER I CERTIFICATI SPECIFICI, E VALORI PUNTUALI, CONTATTARE FINCIBEC SPA - FOR SPECIFIC CERTIFICATES AND DATA, CONTACT FINCIBEC S.P.A - FÜR SPEZIELLE ZERTIFIKATE UND PUNKTWERTE, FINCIBEC S.P.A. KONTAKTIEREN - POUR LES CERTIFICATS SPÉCIFIQUES ET LES VALEURS PONCTUELLES, CONTACTER FINCIBEC S.P.A - PARA LOS CERTIFICADOS ESPECÍFICOS Y LOS VALORES CONCRETOS, CONTACTE CON FINCIBEC S.P.A - ВО ВОПРОСАХ СПЕЦИАЛЬНЫХ СЕРТИФИКАТОВ И ПОКАЗАТЕЛЕЙ СВЯЖИТЕСЬ С FINCIBEC SPA.

ESCLUSO PEZZI SPECIALI ED ELEMENTI DECORATIVI
 WITH THE EXCEPTION OF SPECIAL PIECES AND DECORS - A L'EXCEPTION DE PIÈCES SPÉCIALES ET ÉLÉMENTS DÉCORATIFS - AUSSCHLIEBLICH FORMSTÜCKE UND DEKORTEILE - EXCLUIDO PIEZAS ESPECIALES Y ELEMENTOS DECORATIVOS





CENTURY

Via Radici in Monte, 19
42014 Roteglia (RE) Italy

Tel. +39 0536 855511
Fax Italia +39 0536 851239
Fax Export +39 0536 855541

www.century-ceramica.it
info@century-ceramica.it

FINCIBEC S.p.A.

Sede legale: Via Valle d'Aosta, 47
41049 Sassuolo (Mo) Italy
Gruppo Fire S.R.L.

FINCIBEC USA INC.
420 Columbus Avenue
Valhalla N.Y. 10595 USA
info@fincibecusa.com



FINCIBEC S.p.A. socio di: